



Best Practice Guide to Cable Ladder and Cable Tray Systems

Channel Support Systems and other Associated Supports



BEAMA Best Practice Guide to Cable Ladder and Cable Tray Systems Including Channel Support Systems and other Associated Supports

Companies involved in the preparation of this Guide



Contents

INTRODUCTION	5
DEFINITIONS AND ABBREVIATIONS	6
1. Packing Handling and Storage	8
1.1 General Packing and Handling	8
1.2 Loading and offloading recommendations	9
1.3 Storage	11
2A. Installation of the system	12
2.1 Common tools for Installation	12
2.2 Structural characteristics	12
2.3 Support Systems	18
2.4 Straight cable ladder and cable tray lengths	29
2.5 Coupler types (refer to manufacturer's literature)	32
2.6 Fixings	36
2.7 Fittings	36
2.8 Accessories	39
2.9 Site modification	39
2.10 Earth protection and EMC	40
2B. Installation of Cable	41
2.11 Preparation	41
2.12 Wiring Regulations	41
2.13 Power Cables	41
2.14 Data Cables	46
2.15 Expansion	46
2.16 Electro Mechanical Effects	46
3. Environment	48
3.1 Selecting the right material and finish	48
3.2 Finishes	56
3.3 Non-Metallic systems	61
3.4 Loadings	63
3.5 Temperature	65
4. Health & Safety	67
5. Maintenance	68
5.1 Inspection	68
5.2 Removal of cables	68
5.3 On site repairs	68
6. Sustainability	69
6.1 Sustainable development	69
6.2 REACH regulations	69
6.3 The management of WEEE and RoHS	69
6.4 Environmental footprint	70
7. Applicable Standards	71
Companies involved in the preparation of this Guide	72



FIGURES

Figure 1:	Methods of removal	9
Figure 2:	Loaded beams	13
Figure 3:	Channel Support Systems	20
Figure 4:	Use of Brackets with channel	20
Figure 5:	Typical types of Base Plates	21
Figure 6:	Beam clamps	22
Figure 7:	Channel type cantilever arms	23
Figure 8:	Trapeze hangers using channel	23
Figure 9:	Trapeze hangers other than using channel	25
Figure 10:	General installation with ladder	26
Figure 11:	Threaded rod suspension brackets	26
Figure 12:	Wall support brackets	27
Figure 13:	Overhead hanger	28
Figure 14:	Hold down brackets and clips	28
Figure 15:	Schematics of the SWL Type tests I – IV for cable ladder and cable tray	30
Figure 16:	Expansion couplers	32
Figure 17:	Typical Expansion Coupler Location	33
Figure 18:	Typical graph for determining the expansion coupler setting gap	34
Figure 19:	Bendable couplers	35
Figure 20:	Vertical hinged couplers	35
Figure 21:	Horizontal hinged couplers	36
Figure 22:	Support locations for cable ladder fittings and cable tray fittings	38
Figure 23:	Cable guides for pulling cables	42
Figure 24:	Cable pulling tools	44
Figure 25:	Cable fastening devices	45
Figure 26:	Galvanic Series Chart	50

TABLES

Table 1:	Minimum internal bending radii of bends in cables for fixed wiring	43
Table 2:	Spacings of supports for cables in accessible positions	45
Table 3:	Limiting electrical potential differences to minimise corrosion effects	50
Table 4:	Description of typical atmospheric environments related to the estimation of corrosivity categories	52
Table 5:	Life to first maintenance for a selection of zinc coating systems in a range of corrosivity categories	54
Table 6:	Steel and zinc coating thickness	56
Table 7:	Susceptibility to zinc whiskers / zinc flakes by finish	60

BEAMA Best Practice Guide to Cable Ladder and Cable Tray Systems Including Channel Support Systems and other Associated Supports

Introduction

This publication is intended as a practical guide for the proper and safe* installation of cable ladder systems, cable tray systems, channel support systems and associated supports. Cable ladder systems and cable tray systems shall be manufactured in accordance with BS EN 61537, channel support systems shall be manufactured in accordance with BS 6946.

It is recommended that the work described be performed by a competent person(s) familiar with standard electrical installation practices, electrical equipment, and safety of electrical wiring systems.

These guidelines will be particularly useful for the design, specification, procurement, installation and maintenance of these systems.

Cable ladder systems and cable tray systems are designed for use as supports for cables and not as enclosures giving full mechanical protection. They are not intended to be used as ladders, walk ways or support for people as this can cause personal injury and also damage the system and any installed cables.

*** Safe use of these products is best ensured by installing parts that have been designed and tested together as a system.**

This guide covers cable ladder systems, cable tray systems, channel support systems and associated supports intended for the support and accommodation of cables and possibly other electrical equipment in electrical and/or communication systems installations.

This guide does not apply to conduit systems, cable trunking systems and cable ducting systems or any current-carrying parts.

DISCLAIMER

This publication is subject to the copyright of BEAMA Ltd. While the information herein has been compiled in good faith, no warranty is given or should be implied for its use and BEAMA hereby disclaims any liability that may arise from its use to the fullest extent permitted under applicable law.

© BEAMA Ltd 2012

Copyright and all other intellectual property rights in this document are the property of BEAMA Ltd. Any party wishing to copy, reproduce or transmit this document or the information contained within it in any form, whether paper, electronic or otherwise should contact BEAMA Ltd to seek permission to do so.

Definitions and Abbreviations

Accessory	Component used for a supplementary function e.g. to join two components together, clamp or fix to walls, ceilings or other supports, covers and cable retainers
Associated supports	Bespoke supports for cable tray and cable ladder other than BS 6946 channel supports
Cable cleats	Used within an electrical installation to restrain cables in a manner that can withstand the forces they generate, including those generated during a short circuit.
Cable ladder	System component used for cable support consisting of supporting side members, fixed to each other by means of rungs
Cable ladder system	Assembly of cable supports consisting of cable ladder lengths and other system components
Cable ties	Is a type of fastener, especially used for binding and organising several cables or wires together or to a cable management system
Cable tray	System component used for cable support consisting of a base with integrated side members or a base connected to side members <i>Note: cable tray includes perforated tray and wire mesh</i>
Cable tray system	Assembly of cable supports consisting of cable tray lengths and other system components
Channel support systems	A light structural support system usually consisting of steel channel section (strut), steel brackets, channel nuts and set screws <i>Note: channel support systems comply with BS 6946</i>
Coefficient of linear expansion	The change in length per unit length per unit rise in temperature expressed in degrees C ⁻¹ .
Competent person	Person who possesses sufficient technical knowledge, relevant practical skills and experience for the nature of the work undertaken and is able at all times to prevent danger and, where appropriate, injury to him/herself and others
Damage	With relation to cable management can be represented by broken welds, severely deformed / buckled sections
Deflection	The elastic movement of the section as a result of imposed loading
Eccentric loads	A load imposed on a structural member at some point other than the centroid of the section
Electrical continuity	The ability of a system to conduct electricity within prescribed impedance limits

Electromagnetic compatibility	A system's ability to neither radiate nor conduct electromagnetic energy in such a manner as to cause unwanted effects
Equipotential bonding	Electrical connection maintaining various exposed-conductive-parts and extraneous-conductive-parts at substantially the same potential
Fitting	System component used to join, change direction, change dimension or terminate cable tray lengths or cable ladder lengths
Fixings	Nuts, bolts, washers etc <i>(Internal fixings are used for connecting system components together as recommended and supplied by the cable support system manufacturer)</i> <i>(External fixings are used for connecting system components to an external structure and are not normally supplied by the cable support system manufacturer)</i>
HDG finish	Steel hot dip galvanized after the product is manufactured
Imposed load	Any load other than the weight of the structure itself. (Imposed loads can include electrical cables and equipment, wind, ice and snow)
MICC (cable)	Mineral insulated copper clad
Non-metallic	System which consists of uPVC (Unplasticised Polyvinyl Chloride) or GRP (Glass Reinforced Polymer)
PG finish	Steel pre-galvanized before the product is manufactured
Point load	A concentrated load at a single point
Safe working pull out load	The maximum allowable load on a channel nut connection when applied perpendicularly to the strut length <i>(BS 6946:1988 Requirements for safe pull out loads – the test failure load shall be a minimum of three times the safe working pull out load)</i>
Safe working slip load	The maximum allowable load on a channel nut connection when applied parallel to the strut length <i>(BS 6946:1988 Requirements for safe working slip – the test load required to give continuous slip shall not be less than three times the safe working slip load.)</i>
Span	Distance between the centres of two adjacent support devices
SWL (safe working load)	Maximum load that can be applied safely in normal use
UDL (Uniformly Distributed Load)	Load applied evenly over a given area

Packing Handling and Storage

1.1 General Packing and Handling

1.1.1 Straight lengths of trays, ladders, covers and channel

These shall be packed in bundles using adequate banding* and balanced at the centre.

** It is recommended that where possible non-metallic banding is used in order to avoid rust stains forming on galvanized products and contamination of stainless steel products.*

Where products of five metre lengths or above are packed in bundles, they shall be supported with a minimum of three timber bearers which provide sufficient clearance to accommodate the forks of a forklift truck. Bearers shall be spaced evenly along the length of the bundle.

Where shorter length products are packed in bundles, they shall be supported with a minimum of two timber bearers which provide sufficient clearance to accommodate the forks of a forklift truck. Bearers shall be spaced evenly along the length of the bundle.

Bundles should be placed on a flat level surface with timber bearers. If bundles are stacked on top of one another they should be aligned vertically. The handler is responsible for ensuring that the stack is stable. The working height and load capacity of the storage facility and/or transport vehicle should not be exceeded.

1.1.2 Boxed and bagged parts

Boxes and bags should be stacked onto suitably sized pallets for handling by a fork lift truck.

Pallets of parts must be kept dry and stacking should be avoided.

1.1.3 Tray and Ladder Fittings

Small parts should be stacked onto suitably sized pallets for handling by a forklift truck. Each pallet should be suitably wrapped in order to secure the parts. Pallets of parts must be kept dry and stacking should be avoided.

Large parts should be packed and transported in the same way as straight lengths detailed above.

1.1.4 Specialised Packaging

Where delivery involves transshipment or rough handling en route it is recommended that products are packed in wooden crates or wooden cases.

1.2 Loading and offloading recommendations

Site deliveries should preferably only be made where suitable mechanical handling equipment is available on site.

The delivered material must be treated with care. Lifting must only be carried out from the sides and the forklift truck tines must pass below a complete bundle, see Figure 1a. Tines must never* be inserted into the end of the bundle, see Figure 1b unless provision is made such as special packaging and/or extended tines, otherwise the safety limits of the lifting vehicle may be exceeded and damage may be caused to the equipment being lifted.

For offloading by crane suitable lifting beams should be inserted from side to side beneath a bundle and these must be sufficiently long to avoid undue pressure on the edges of the bottom components.

The tensioned banding used for securing bundles of equipment during transport is not suitable for lifting purposes. When cutting this banding appropriate eye protection must be worn to avoid injury.

Sheared steel (particularly pre-galvanized or stainless steel) does have relatively sharp edges and protective gloves must be worn during handling.



Figures 1
*Methods of
removal*

Figure 1a
Correct method of removal

*Except when utilising extended forks and specialised packaging

Figures 1
Methods of
removal



Figure 1b
Incorrect method of removal

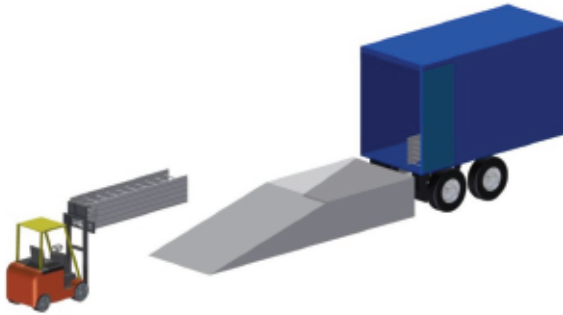

Figure 1c
Correct method of removal from a container

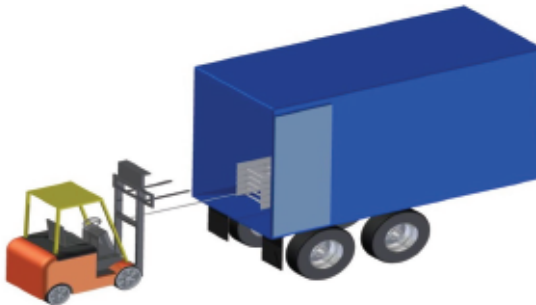

Figure 1d
Incorrect method (using a pulling chain) of removal from a container

For shipment using containerisation special provision should be made for example a ramp which allows access for lifting by forklift from one end or both ends, see Figures 1c and 1d.

1.3 Storage

In order to store Cable Tray Systems, Cable Ladder Systems, Channel Support Systems and other supports safely and maintaining them in their delivered condition, the following guidelines should be considered:-

Products which are either Hot Dip Galvanized (HDG) after manufacture, stainless steel or non-metallic can be stored outside without cover (excluding boxed items). When stored outside products should be stacked in a method that ensures adequate drainage. However outside storage is not recommended for galvanized products due to wet storage stain (see below). Ideally, all metallic products should be stored undercover in a dry, unheated environment and be loosely stacked off the ground to ensure adequate ventilation. It is important that products that have different finishes are kept apart.

Products Pre Galvanized (PG) before manufacture should always be protected and stored in a well ventilated and dry location, and stacked as above.

Any components packaged in degradable bags, boxes, cartons etc. should always be stored in a well ventilated and dry location.

All products should be stored away from areas where processes or activities could cause damage and/or contamination. Due consideration should be given to ensure products are stacked together by type and width and in such a way as to prevent toppling.

1.3.1 Wet Storage Stain

If galvanized products are allowed to become wet whilst stacked awaiting transportation or installation the finish may quickly suffer from unsightly staining and powdering on the surface. This is commonly known as 'wet storage stain' and detracts from the overall appearance of the product. Generally this condition does not however, reduce the life expectancy of the corrosion resistance of the finish.

Where equipment has been affected by wet storage stain the unsightly marking will usually become much less prominent and will often disappear completely within months of installation. *The stain is converted to zinc carbonate by reaction with atmospheric CO₂ so providing a protective patina.*

Installation of the system

The following recommendations are intended to be a practical guide to ensure the safe and proper installation of cable ladder and cable tray systems and channel support and other support systems. These guidelines are not intended to cover all details or variations in cable ladder and cable tray installation and do not provide for every installation contingency.

It is recommended that the work described in the following section is carried out by competent persons who are familiar with the products being installed and the safety standards associated with them.

2.1 Common tools for Installation

The following tools are commonly used for installation of cable management systems:

Metal Cutting Saw/Grinder	Levelling Device
Touch Up Material	Tape Measure
Screwdrivers	Set Square
Drill with Bits	G Clamps
Files	Torque Wrench
Spanners	Socket Wrench and Sockets
Appropriate Safety Equipment (PPE)	

2.2 Structural characteristics

When considering the installation of the cable supports system it is imperative to avoid the cutting or drilling of structural building members without the approval of the project leader on site.

Cable ladders, cable trays and their supports should be strong enough to meet the load requirements of the cable management system including cables and any future cable additions and any other additional loads applied to the system.

Support systems can be broken down into a number of elements or components. To design a safe system it is necessary to check each element in turn to ensure:

- that it can safely support the loads being imposed upon it, and
- that the proposed fixings to adjacent components are also sufficient for the intended load and
- that any declared deflection limits are not exceeded.

Consult the manufacturer for any further assistance on system design.

On many occasions cable ladder or cable tray is installed in circumstances where it will only ever carry a light cable load, possibly just one or two cables, and its main role is to physically secure and protect its contents. In these situations it is often the inherent ruggedness or the aesthetics of the cable ladder or cable tray design which bear most heavily on the specification decision. However, when a support system is required to be more heavily loaded it is useful to have knowledge of the theoretical aspects of rudimentary structural design in order to ensure that the completed system does fulfil its purpose with the greatest safety and economy.

2.2.1 Beams

Any installed cable ladder, cable tray or channel support system can be considered structurally as a loaded beam (Figures 2); four basic beam configurations may be found in a typical installation:

- Simply supported beam
- Fixed beam
- Continuous beam
- Cantilever

2.2.1.1 Simply supported beam

A single length of cable ladder, cable tray or channel mounted on, but not restrained by two supports, represents a simply supported beam (Figure 2a), which will bend as any load is applied to it with the supports offering no restraint to this bending.

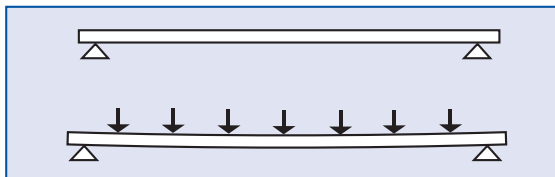

Figure 2a
Simply supported beam

Figures 2
Loaded beams

This simple beam arrangement is fairly onerous and does not realistically model many real life installations; thus the load/deflection information given in this guide is based upon more typical multi-span configurations, which also incorporate joints. However, if an un-jointed single span does actually occur the Safe Working Load can, as a practical guide, be taken as 0.5 of that indicated by the manufacturer's multi-span loading details.

Figures 2
*Loaded
beams*

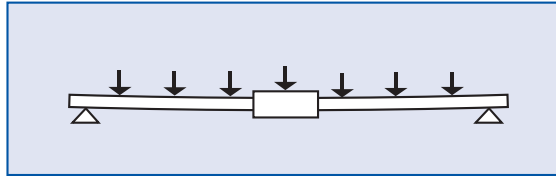

Figure 2b
Mid-span joint

The introduction of a mid-span joint (Figure 2b) into a simple beam arrangement makes analysis far more complex. This arrangement represents the most testing situation for a cable ladder, cable tray or channel support joint. For this configuration the manufacturer should be consulted for the safe working load.

2.2.1.2 Fixed beam

A fixed beam arrangement (Figure 2c) is a single structural member with both ends fastened rigidly to supports. Compared with a simple beam this degree of restraint does significantly increase the ability of the beam to carry loads but it is unlikely that cable ladder or cable tray can, in practice, be secured sufficiently rigidly to be considered as a fixed beam.

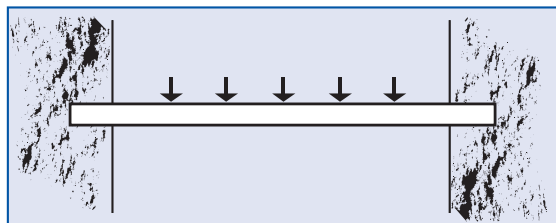
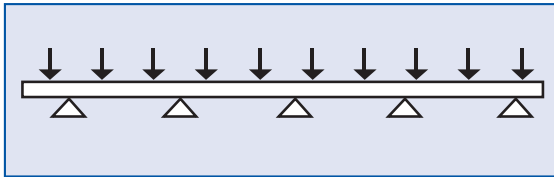

Figure 2c
Fixed beam arrangement

However, in the context of a complete cable ladder or cable tray system the main importance of the fixed beam configuration is that some appreciation of its properties, along with those of a simple beam arrangement, will assist the designer to understand the more complex behaviour of a continuous, multispan cable tray installation.

2.2.1.3 Continuous beam

A typical multi-span cable ladder or cable tray installation behaves largely as a continuous beam and the greater the number of spans the closer the similarity. However in practice a run must contain joints and it can also never be considered of infinite length so it is important to appreciate how its characteristics do vary from span to span and how these variations should be taken into account when designing the installation.



Figures 2
Loaded
beams

Figure 2d
Cable tray loaded uniformly

When a run of cable tray is loaded uniformly (Figure 2d) from end to end the load on each span is effectively in balance with the loads on the adjacent spans.

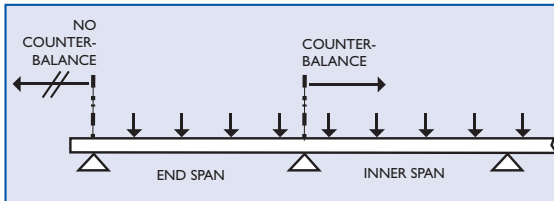

Figure 2e
End spans not so counterbalanced

This causes the inner spans to behave substantially as fixed beams imparting to them a considerable load carrying ability. However the end spans (Figure 2e) of the installation are not so counterbalanced, thus they perform more akin to simple beams, with consequently lower load carrying capabilities.

Because of this it may be necessary to reduce the end span to less than the intermediate span length. The need for this depends on the ladder/tray manufacturer's recommendations, which should be based on load tests carried out to BS EN 61537.

See section 2.4 Installation of straight cable ladder and cable tray lengths for further details.

2.2.1.4 Cantilever beam

This type of arrangement most commonly occurs with the brackets which are used to

support cable ladder or cable tray, these being fixed to the structure at one end only. For cable ladder or cable tray installations it is usual to consider the cable load to be uniformly distributed along the length of the cantilever arm (i.e. across the width of the ladder or tray); however, if cables will be bunched then their combined weight effectively acts as a point load on the arm so the bunch should be laid nearest the supported inner end (Figure 2f).

Consult manufacturers for safe working loads on cantilever arms. Manufacturers may supply safe working loads for both uniformly distributed loads and point loads at the ends of the cantilever arms.

Figures 2
Loaded beams

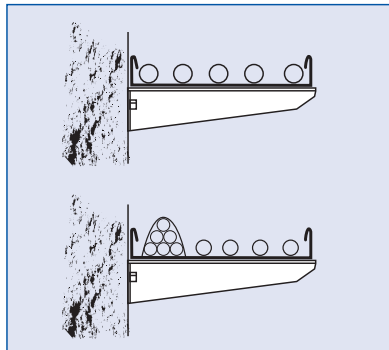

Figure 2f
Bunch laid nearest the support inner-end

2.2.2 Columns

Any vertically orientated component, whether cable ladder, cable tray or support, acts structurally as a column; it is not usual to consider cable ladder or cable tray in this way because they are not designed for this purpose.

Supports are however, frequently used as vertical columns.

The downward load which can be applied to the end of a column is proportional to the column length and the compressive strength of the material from which it is made. However there are few real applications where no loads are applied from other directions and since the effects of such loads are very significant it is important to consider the totality of the intended structure rather than focus simply only on the loads applied down the column.

Proper structural analysis must take detailed account of any side forces or eccentric loads caused by cantilever arms or other brackets fixed to the vertical channel. Such calculations must be carried out by a competent person such as a structural engineer. Consult the manufacturer for safe loading data for supports used as columns.

2.2.3 Deflection

All beams will deflect (Figure 2g) when a load is imposed. The magnitude of the deflection depends upon the following factors:

- The load on the beam,
- The load type – UDL (uniformly distributed load) or point load,
- The distance between the beam supports (span),
- How the beam is fixed and supported,
- The size of the beam,
- The material of the beam.

A beam's stiffness is derived from its cross sectional shape (defined by its 'Moment of Inertia or 'I' Value'), and the stiffness of the material from which it is made (defined by its 'Modulus of elasticity or 'E' value'). The greater the 'I' value of beam and the greater the 'E' value of its material, the greater the beam stiffness and the smaller the deflection when a load is imposed.

The deflection of a beam is proportional to the applied load. For example by doubling the applied load, the deflection will also be doubled (Figure 2g).

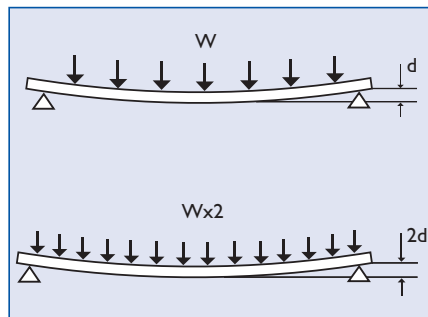

Figure 2g

Doubling the applied load doubling the deflection

Figures 2
Loaded beams

The position and type of load will also affect the amount of deflection on the beam. A Point Load will increase the deflection on a beam compared to a UDL of the same value. If designing a system with a point load at mid span, assume that the deflection will be doubled compared to the same load applied as a UDL.

If Deflection is an important factor, the easiest way to reduce it is to either; reduce the distance between the supports (the span), use a bigger section beam, or reduce the imposed loading.

Consult the manufacturer for details of deflections at their published safe working loads.

Deflection limits

Deflection limits are usually expressed as a proportion of the support span (L) or the product width (W). In most UK steel construction, the allowable deflection at safe working load is L/200 for beams and L/180 for cantilevers, based on UK steel design standards.

Cable ladders, cable trays and their supports made to BS EN 61537 are allowed much greater deflections than this as listed below, so if deflections are important the manufacturer should be consulted to state what deflections occur at the safe working loads.

Cable ladder and cable tray made to BS EN 61537

At the safe working load, the maximum allowable deflection along the length is L/100, and the maximum allowable deflection across the width is W/20, based on load test measurements.

Supports: beams, hangers & cantilevers made to BS EN 61537

At the safe working load the maximum allowable deflection is L/20, based on load test measurements.

Supports: channel support systems made to BS 6946

At the safe working load the maximum allowable deflection is L/200 for beams & L/180 for cantilevers, based on calculations to UK steel design standards.

2.3 Support Systems

Where cable ladder and cable tray support systems are fixed to primary supports (e.g. structural steel work or elements of the building) it is important to ensure that the primary supports are strong enough to carry the imposed loads. This is generally the responsibility of the building designer and not the cable tray or cable ladder manufacturer.

The fixings used to connect the cable ladder and cable tray support systems to the primary supports also need to be checked to ensure that they are strong enough. This is normally the responsibility of the installer and/or the building designer.

2.3.1 Using channel to BS 6946

2.3.1.1 General

A Channel Support System (Figures 3) is a standardised system used in the construction and electrical industries for light structural support, often for supporting wiring, plumbing or mechanical components such as air conditioning or ventilation systems. The system usually consists of a steel channel section (strut), steel brackets, channel nuts and set screws (Figure 3a).

The strut is usually formed from 1.5 mm or 2.5 mm thick steel and is generally available in either (41x41) mm or (41x21) mm profiles and with either a plain or a slotted base. Other sizes and profile combinations are available which are usually manufactured by welding strut sections together in different formats.

Figures 3
Channel Support
Systems



Figure 3a
Assembled support system using channel

Systems can be assembled from strut, associated bracketry and fixings to produce: beams, columns, hangers, cantilevers and frames. Assembly details and a wide range of bracketry and sundries can be found in manufacturer's catalogues.

The load carrying capabilities of the support system are based on a combination of calculations and load tests which are defined in BS 6946. This information should be published by the system manufacturer.

To maintain the system integrity it is essential that all the parts come from the same manufacturer and have been tested together as a system. The use of mixed parts from different manufacturers is potentially dangerous and may make void any product warranty.

2.3.1.2 Channel nuts

When a bracket is fixed to a channel using a channel nut and set screw, there are two safe working load values (slip and pull out) which should be quoted by the manufacturer (Figure 3b). To achieve the designated design slip and pull out ratings, all connections should be made using clean, dry components and tightened to the manufacturers stated torque value. Over tightened fixings could lead to damaged parts and reduced strength.

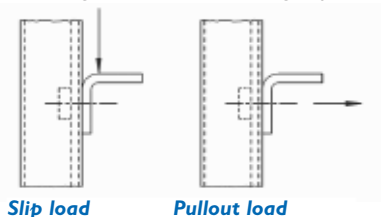

Figure 3b
Direction of applied load to cause slip or pullout

It must be emphasised that proper location and tightening of the channel nut within the channel is vital to the performance of the channel nuts (Figure 3c). A fastener that is not tightened to the manufacturers recommended torque will not consistently meet the manufacturers minimum published design loads.

Figures 3
Channel
Support
Systems



Figure 3c
Typical types of channel nuts

2.3.1.3 Brackets

Framework brackets of all types are generally used to aid in the onsite fabrication of a support structure. Brackets (Figure 4) are available to cover most applications and are generally connected to channels in the following fashion:

- Insert the channel nut between the flanges of the channel and rotate it clockwise until the slots in its face align with the channel flanges
- Fit the flat washer to the set screw
- Position the bracket such that the holes are aligned with the channel nut and place it over the channel
- Pass the set screw (with washer fitted) through the hole in the bracket and into the channel nut
- Tighten the set screw to the required torque

The example details a 90° angle bracket in conjunction with channel and the relevant fixings

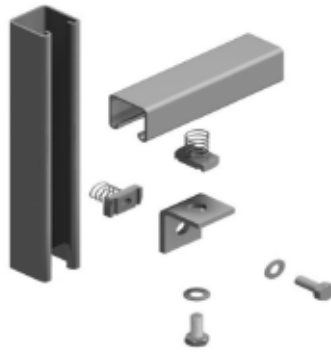

Figure 4
Use of Brackets with channel

2.3.1.4 Base plates

Base plates (Figures 5) are generally used to fix vertical lengths of channel section to a firm floor and are generally connected to channels in the following fashion:

- Fix the base plates in place
- Locate the channel nuts into the channel sections
- Insert the channel section into the base plate
- Align the channel nuts with the fixing holes in the base plate
- Fit the set screw and the flat washers through the base plate and into the channel nuts
- Tighten the set screws



Figure 5a



Figure 5b



Figure 5c

Figures 5
*Typical types
of Base Plates*

2.3.1.5 Beam clamps – window type

Window type beam clamps (Figure 6a) are generally used to fix lengths of channel section to existing supporting beams and are generally connecting channel to beam for medium loads as shown:

- Insert the channel through the hole in the bracket
- Fit the cone pointed set screw through the threaded fixing hole in the bracket
- Position the inner face of the beam clamp against the support structure
- Tighten the set screw to fix the beam clamp in place

Figures 6
Beam clamps

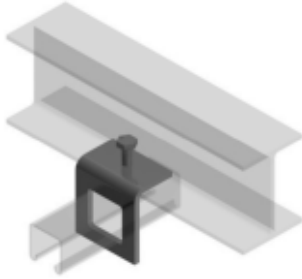

Figure 6a

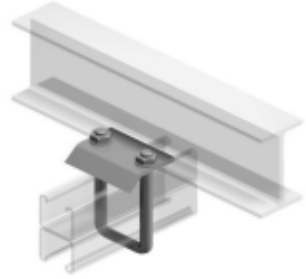

Figure 6b

2.3.1.6 Beam clamps – ‘U’ bolt type

‘U’ bolt type beam clamps (Figure 6b) are generally used to fix lengths of channel section to existing supporting beams and are generally connecting channel to beam for heavier duty loads as shown:

- Position the U Bolt over the channel and insert it through the holes in the bracket
- Fit the flat washers and nuts to the U Bolt
- Position the U Bolt such that it rests against the edge of the support structure
- Tighten the nuts to fix the beam clamp in place

Note: Beam Clamps must be used in pairs (one each side)

2.3.1.7 Channel type cantilever arms

Channel type cantilever arms (Figure 7) are generally used to provide support to services on a framework installation and are generally connected to channels in the following fashion:

- Insert the channel nuts between the flanges of the channel; and rotate clockwise until the slots in the faces align with the channel flanges
- Fit the flat washers to the set screws
- Position the cantilever arm such that the clearance holes in the back plate are aligned with the threaded holes in the channel nuts
- Pass the set screws (with the washer fitted) through the holes in the backplate into the channel nuts
- Tighten the set screws



Figure 7
Channel type cantilever arms

2.3.1.8 Channel type trapeze hangers

Trapeze hangers (Figures 8) are suitable for use with cable ladder and cable tray, supported by threaded rods hung from ceiling brackets, channel support systems or from beam clamps attached to joists or steel beams.

When several levels of cable ladder or cable tray are mounted on the same threaded rods in a multiple level installation, it is important to ensure that the total load on any pair of rods does not exceed the safe working load of the rods or their attachment points.

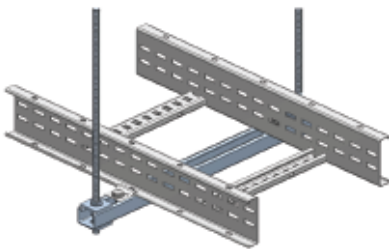

Figure 8a
Installation with ladder

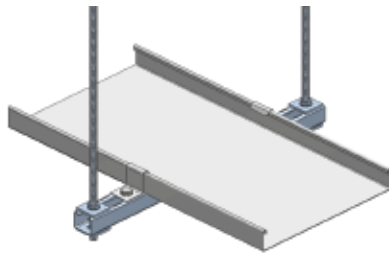

Figure 8b
Installation with tray

Figures 8
*Trapeze hangers
using channel*

Assembly is generally carried out in the following order:

Plain channel

- Secure the top of the threaded rods in accordance with the chosen suspension method.
- Screw a hexagonal nut onto each of the threaded rods and set the nuts at the desired height on the rod.
- Pass a square washer along each rod and screw a channel nut onto the end of each rod.
- Align the channel with the channel nuts and rotate the channel nuts clockwise until the slots in the nuts align with the flanges of the channel.
- Tighten the hexagonal nuts above the channel to secure the assembly.

Slotted channel

May be used with single or multiple tiers of trapeze hangers.

- Secure the top of the threaded rods in accordance with the chosen suspension method.
- Screw a hexagonal nut onto each of the threaded rods and set the nuts at the desired height on the rod.
- Pass a square washer along each rod and pass the ends of the rods through the slotted channel to form a trapeze.
- Secure the trapeze in place by passing a square washer along the rods and screw a hexagonal nut onto the end of each rod.
- Tighten the hexagonal nuts above and below the channel trapeze hanger to secure the assembly.

2.3.2 Supports not using channel to BS 6946

2.3.2.1 Trapeze hangers

Trapeze hangers (Figures 9) are suitable for use with cable ladder and cable tray, supported by threaded rods hung from ceiling brackets, channel support systems or from beam clamps attached to joists or steel beams.

When several levels of cable ladder or cable tray are mounted on the same threaded rods in a multiple level installation, it is important to ensure that the total load on any pair of rods does not exceed the safe working load of the rods or their attachment points.

Consult the manufacturer for specific details.

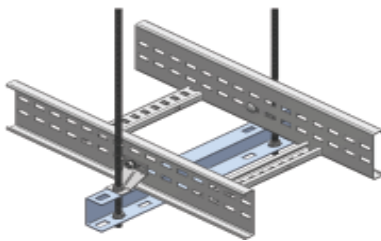

Figure 9a
Installation with ladder

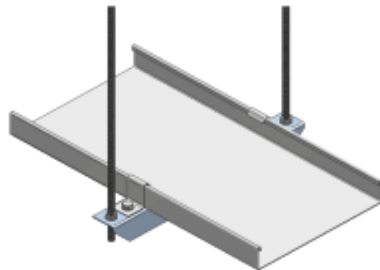

Figure 9b
Installation with tray

Figures 9
*Trapeze hangers
other than using
channel*

2.3.2.2 Cantilever arms

Cantilever arms enable horizontal runs of cable ladder or cable tray to be mounted to vertical steel, concrete or masonry surfaces or to channel support systems (Figure 10).

Consult the manufacturer for specific details.

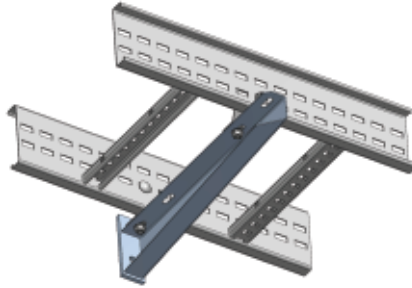

Figure 10
General installation with ladder

2.3.2.3 Threaded rod suspension brackets

Threaded rod suspension brackets (Figures 11) are useful when space is limited. When several levels of cable ladder or cable tray are mounted on the same threaded rods in a multiple level installation (Figure 11b), it is important to ensure that the total load on any pair of rods does not exceed the safe working load of the rods or their attachment points.

Consult the manufacturer for specific details.

Figures 11
Threaded rod
suspension
brackets

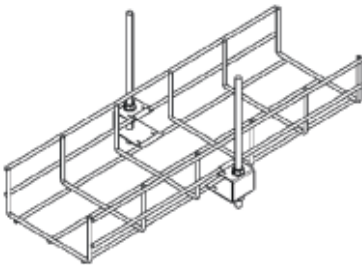

Figure 11a
General installation mesh tray

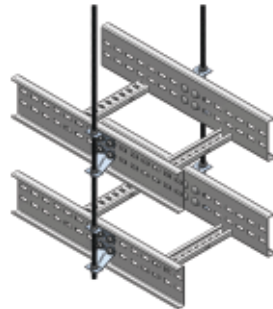

Figure 11b
Stacked installation Ladder

2.3.2.4 Wall support brackets

Wall support brackets (Figures 12) are an effective way of fixing any width of cable ladder or cable tray, running either vertically or horizontally, to a vertical support.

Consult the manufacturer for specific details.

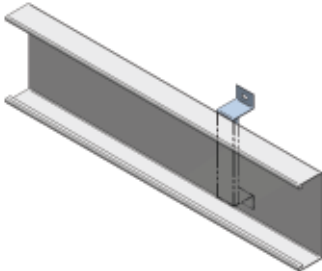

Figure 12a
General installation horizontal
tray (small bracket)

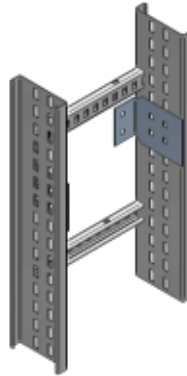

Figure 12b
General installation vertical ladder

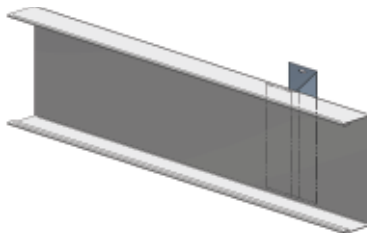

Figure 12c
General installation horizontal tray (large bracket)

Figures 12
Wall support
brackets

2.3.2.5 Overhead hangers

(Specific to cable tray)

Overhead hangers (Figure 13) enable tray to be supported from a single threaded rod giving easy access for laying cables from one side of the tray only.

Consult the manufacturer for specific details

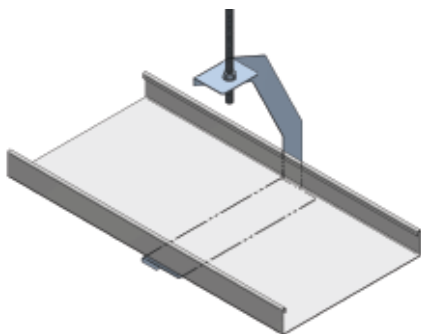

Figure 13
Overhead hanger

2.3.2.6 Hold down brackets and clips

Hold down brackets (Figures 14) and clips are used for securing cable ladder and cable tray to horizontal supports. If allowance for thermal expansion is required then the brackets and clips are generally not fixed to the cable ladder or cable tray.

Consult the manufacturer for specific details.

Figures 14
Hold down
brackets and
clips

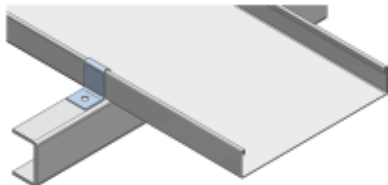

Figure 14a
Typical tray hold down clips

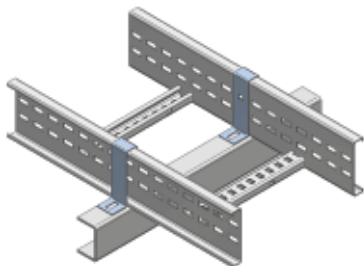

Figure 14b
Typical ladder hold down brackets

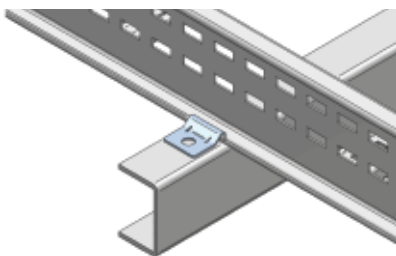

Figure 14c Typical ladder hold down clips

2.3.2.7 Floor and Roof installations

Cable ladders or cable trays should not be laid directly onto the floor or roof of an installation. Cable ladders and cable trays should be mounted far enough off the floor or roof to allow the cables to exit through the bottom of the cable ladder or cable tray. If a channel support system is used for this purpose, mount the channel directly to the floor or roof and attached the cable ladder or cable tray to the channel using the fixings recommended by the manufacturer.

2.4 Straight cable ladder and cable tray lengths

2.4.1 Span size, joint positions and safe loadings

The standard BS EN 61537 states that manufacturers must publish SWL (safe working load) details for their products, and specifies load test methods for determining the SWLs which can be supported by cable ladder and cable tray. There are different types of load test (Figures 15), used dependant on what installation limitations the manufacturer specifies, with regard to span size, possibly with reduced end span size, and positions of joints.

The different test types and the installation conditions for which they are intended are as follows:

IEC load test Type I

Test with a joint in middle of the end span (Figure 15a).

Simulates the worst case installation condition.

Use for installations with joints anywhere.

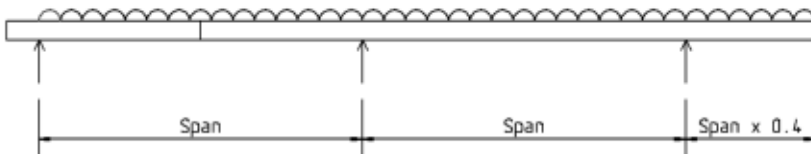

Figure 15a
Load test Type I

Figures 15:
Schematics of the SWL Type tests I – IV for cable ladder and cable tray

IEC load test Type II

Test with a joint in middle of the inner span (Figure 15b), with an optional reduced end span as the manufacturers recommendation.

Simulates an installation condition with span/joint limitations.

Use for installations with no joints in the end spans, with reduced end span as the manufacturer's recommendation.

Figures 15:
Schematics of
the SWL Type
tests I – IV for
cable ladder
and cable tray

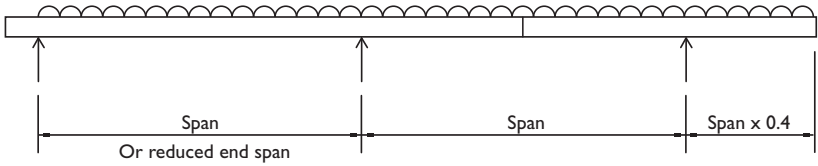

Figure 15b
Load test Type II

IEC load test Type III

Test with joints at manufacturers recommended positions (Figures 15c and 15d), with an optional reduced end span as the manufacturer's recommendation.

Simulates an installation condition with span/joint limitations.

Use for installations with joints at manufacturers recommended positions, with reduced end span as the manufacturer's recommendation.

Test Type III Example 1 – joints at $\frac{1}{4}$ span positions

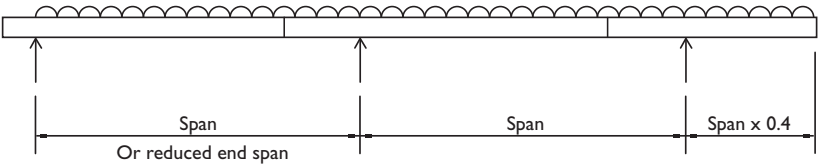

Figure 15c
Load test Type III (example 1)

Test Type III Example 2 – joints at support positions:

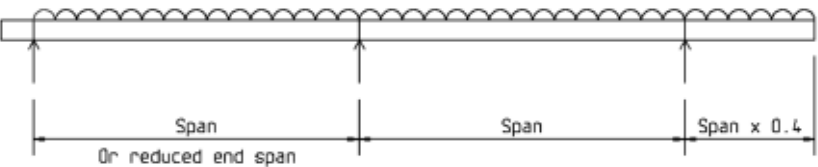

Figure 15d
Load test Type III (example 2)

IEC load test Type IV

A variation on test types I or II, used for products which have a localised weakness in the side member.

The test is identical to test types I & II, but repositioned slightly so that the side member weakness is directly above the middle support.

Use for installations as type I or type II above as appropriate.

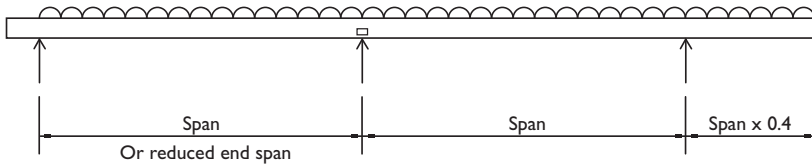

Figures 15:
Schematics of
the SWL Type
tests I – IV for
cable ladder
and cable tray

Figure 15e
Load test Type IV

It is important when using manufacturers loading data to check what test type has been used to produce the SWL data, and hence what installation limitations may apply, particularly with regard to joint positions & end span size.

For calculation of loadings on a cable ladder or cable tray installation, it is important to include all dead loadings and any imposed loadings such as wind, snow and ice.

See section 3.4 for more details.

2.4.2 Straight lengths installation

After the supports are in place, the installation of the cable ladder or cable tray can begin at any convenient location. It is not necessary to begin at one end of the run in all cases. It is ideal if circumstances permit to lay out the system so that joints fall in the desired positions as this will visually aid installation and also maximise the system rigidity.

To begin the installation, place a straight length across two supports so that the ends of the length are not directly on the support. If the support span is equal to or greater than the length of the straight lengths then bolt two lengths together for this step.

Place the next straight length across the next support and attach it to the previous length with a pair of coupler plates and relevant fixings with the bolt heads on the inside of the cable ladder or cable tray unless otherwise specified by the manufacturer.

2.4.3 Installation of longer spans

Manufacturer's published data should be consulted in order to ascertain the maximum span that a product can be used with, and any special provisions required for long spans. Special provisions may be required particularly if used externally where there may be dynamic loadings such as wind & snow; e.g. wider supports, extra supports or bracing, limitations on joint positions.

2.5 Coupler types (refer to manufacturer's literature)

Couplers are used to join together two separate components, whether that may be lengths, fittings or a combination of both. Couplers are supplied in pairs or individually.

2.5.1 Straight coupler

Straight couplers are used for joining together straight lengths and or fittings.

2.5.2 Fitting to fitting coupler

Depending on the manufacturer fitting to fitting couplers are used for joining together cable ladder fittings (bends, tees, risers etc).

2.5.3 Flexible expansion coupler

Flexible expansion couplers (Figures 16) can be used to:

- provide a semi-flexible joint where straight cable ladder or cable tray runs span separate structures between which some relative movement is possible.
- make provision for changes in the length of a straight cable ladder or cable tray runs due to thermal expansion or contraction.

Figures 16
Expansion
couplers

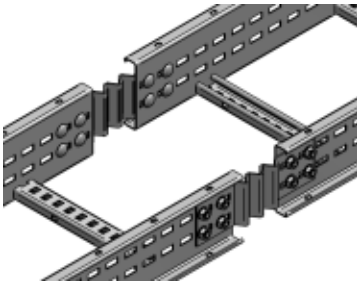

Figure 16a
Concertina expansion coupler

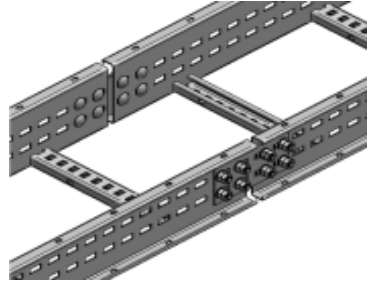

Figure 16b
Sliding expansion coupler

2.5.3.1 Distance between expansion joints

The distance between expansion joints (Figure 17) should be calculated by the following formula.

$$D = E/(KT)$$

Where

D = distance between expansion joints (m)

E = allowable movement for each expansion joint (m)

T = temperature range [Maximum temperature – minimum temperature] (°C)

K = coefficient of linear expansion of the material (°C⁻¹)

Typical values for K

- Mild steel 13×10^{-6}
- Stainless steel grade 1.4404 (316) 16×10^{-6}
- GRP Variable (consult manufacturer)
- PVC 55×10^{-6}

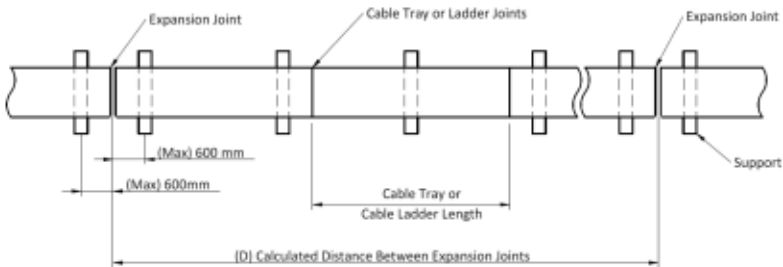

Figure 17
Typical Expansion Coupler Location

2.5.3.2 Example calculation using a typical sliding type expansion coupler

Mild steel cable ladder, with $K = 13 \times 10^{-6} \text{ } ^\circ\text{C}^{-1}$

Allowable movement at each expansion joint $E = 28 \text{ mm} = 0.028 \text{ m}$

Temperature range of installation $T = -15 \text{ } ^\circ\text{C}$ to $+35 \text{ } ^\circ\text{C} = 50 \text{ } ^\circ\text{C}$

Maximum distance 'D' between expansion joints

$$D = E/(KT) = 0.028 / (13 \times 10^{-6} \times 50) = 43 \text{ m}$$

For ease of installation an expansion coupler should be fitted every 14th length of 3m ladder giving 42m between expansion couplers.

Method for determining the installation gap for sliding type expansion couplers.

Using the graph (Figure 18) below:

- Mark the maximum seasonal temperature on line A
- Mark the minimum seasonal temperature on line B
- Draw a diagonal line C between the two marked points on line A and B
- Draw line D horizontally at the temperature the cable ladder or cable tray is to be installed at.
- A vertical line E should then be constructed from the intersection of the diagonal line C and the horizontal line D
- The installed gap setting can read off the base of the graph (F).

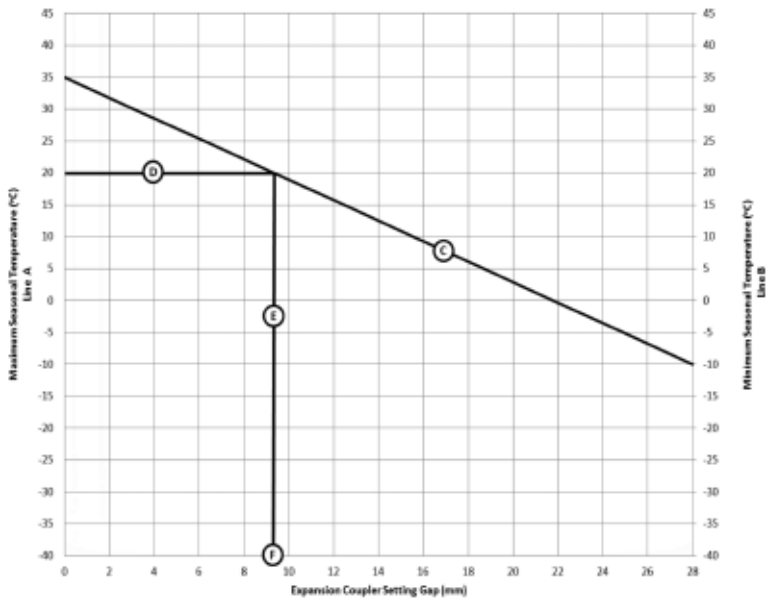

Figure 18

Graph for determining the expansion coupler setting gap

Note the gap setting will vary depending on the manufacturers design. The example above is for a coupler with a total 28 mm expansion range.

2.5.3.3 Example calculation using a typical concertina type expansion coupler

Mild steel cable ladder, with $K = 13 \times 10^{-6} \text{ } ^\circ\text{C}^{-1}$

Allowable movement at each expansion joint $E = \pm 10 \text{ mm} = \pm 0.01 \text{ m}$

Temperature range of installation $T = -20 \text{ } ^\circ\text{C}$ to $+40 \text{ } ^\circ\text{C} = 60 \text{ } ^\circ\text{C}$

Maximum distance 'D' between expansion joints

$$D = E/(KT) = 0.01/(13 \times 10^{-6} \times 60) = 12.8 \text{ m}$$

For ease of installation an expansion coupler should be fitted every 4th length of 3m ladder giving 12 m between expansion couplers.

As the temperature at the time of installation is unknown the expansion movement of the coupler (in this example) would range from + 10 mm to – 10 mm depending on the temperature at the time of installation. The value of 'E' therefore used for the calculation is half of the total range of movement of the coupler.

NOTE at expansion joint positions supports should be no more than 600 mm either side of the joint, unless special strong expansion couplers are available that allow supports to be positioned greater than 600 mm from the joint.

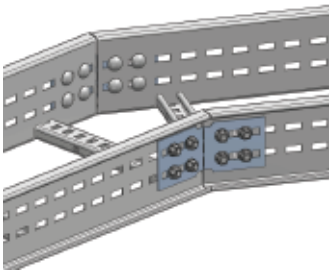

Figure 19
Bendable couplers

2.5.4 Horizontal Adjustable/Bendable coupler

Bendable couplers (Figure 19) can be used for:

- Fabricating fittings on site from cut lengths of cable ladder.
- Correcting minor misalignment problems.
- Coupling lengths of cable ladder to form articulated bends.

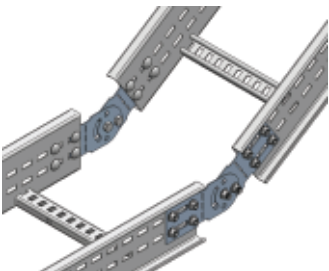

Figure 20
Vertical hinged couplers

2.5.5 Vertical hinged coupler

Vertical hinged couplers (Figure 20) can be used for:

- Fabricating fittings on site from cut lengths of cable ladder.
- Solving minor vertical misalignment problems.
- Coupling articulated risers to adjacent cable ladders.
- Forming risers at non-standard angles.

2.5.6 Horizontal hinged coupler

Horizontal hinged couplers (Figure 21) can be used for:

- Fabricating fittings on site from cut lengths of cable ladder.
- Solving minor horizontal misalignment problems.
- Forming horizontal bends at non-standard angles.

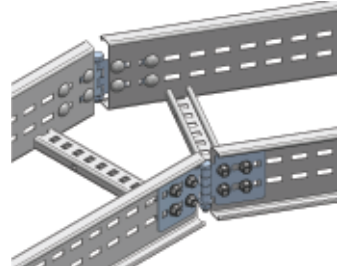

Figure 21
Horizontal hinged couplers

2.6 Fixings

It is important that the manufacturers or responsible vendors recommended fixings should be used and tightened to the specified torque in order to ensure a safe and secure installation of the system including:

- *Adequate mechanical strength,*
- *Electrical continuity (if required),*
- *Resistance to corrosion (see section 3.1 Environment), and*
- *Prevention of damage to cables.*

The use of incorrect or unspecified fixings may result in the above requirements being severely compromised

2.7 Fittings

Fittings are best described as factory fabricated items which facilitate a change of direction and / or width and provide intersections between straight cable ladder or cable tray runs. A standard range of fittings would include such items as a flat bend, inside or outside riser, equal or unequal tee, 4-way crossover & reducer. Other fittings may also be available and consultation with the manufacturer may be necessary. In cable management installations fittings must always be provided with local support.

2.7.1 Radius of cable ladder and cable tray fittings

The radius for cable ladder and cable tray fittings is usually determined by the bending radius and stiffness of the cables installed on the cable ladder or cable tray. Typically the cable manufacturer will recommend a minimum bend allowance for each type of cable. The radius of the cable ladder or cable tray fitting should be equal to or larger than the minimum bending radius of the largest cable installed.

2.7.3 Fittings without integral coupler

Fittings without integral couplers are normally joined together and/or to straight lengths using couplers as used with straight lengths.

2.7.4 Support locations for cable ladder and cable tray fittings

Where fittings are used, supports are usually required under the adjacent straight lengths close to the fitting joints (Figures 22).

Additional supports are sometimes required directly underneath large fittings (see key item 4 in the relevant figures below).

Consult manufacturers' published data for details of the maximum distance between supports & fitting joints, and for which size fittings require additional supports.

1. Straight length tray or ladder
2. Fitting of tray or ladder
3. Support position under adjacent straight length
4. Additional support position under large fittings

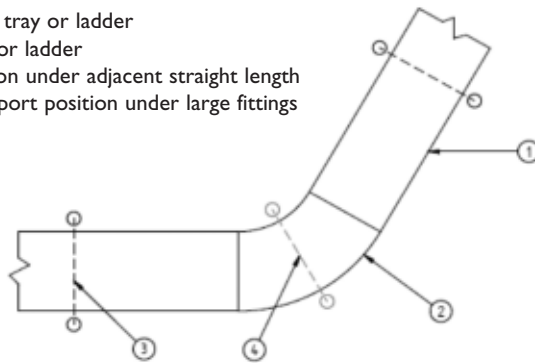

Figure 22a
Flat Elbow support

1. Straight length tray or ladder
2. Fitting of tray or ladder
3. Support position under adjacent straight length

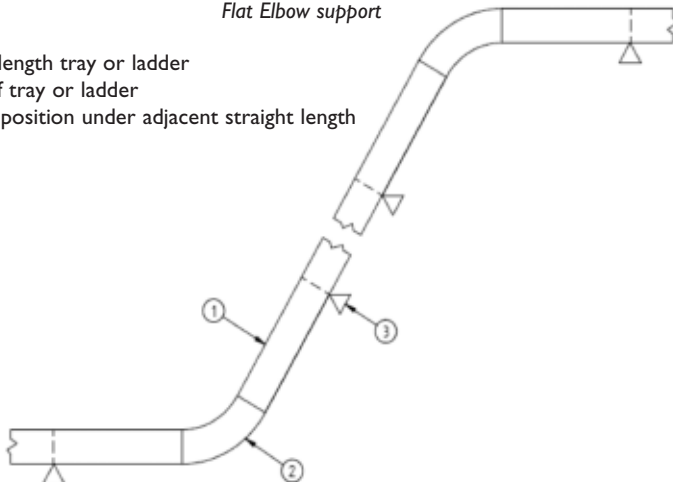

Figure 22b
Riser support

Figures 22:
Support locations
for cable ladder
fittings and cable
tray fittings

Figures 22
Support locations
for cable ladder
fittings and cable
tray fittings

1. Straight length tray or ladder
2. Fitting of tray or ladder
3. Support position under adjacent straight length
4. Additional support position under large fittings

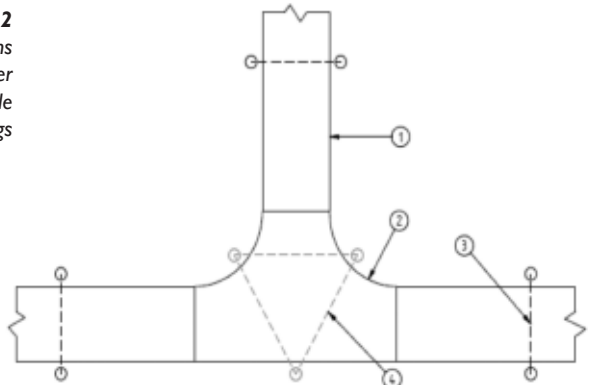

Figure 22c
Tee support

1. Straight length tray or ladder
2. Fitting of tray or ladder
3. Support position under adjacent straight length
4. Additional support position under large fittings

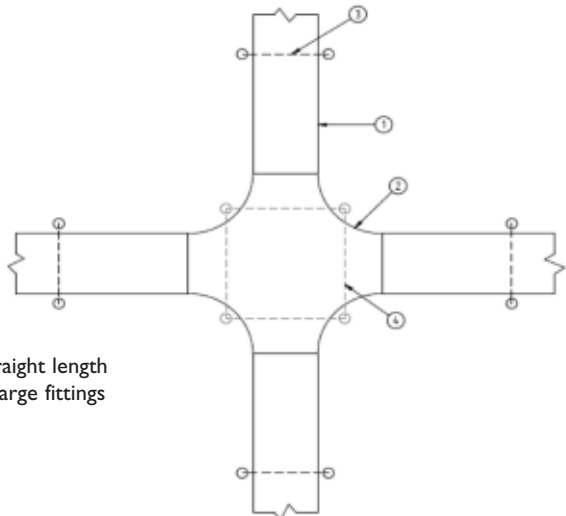

Figure 22d
Crossover support

1. Straight length tray or ladder
2. Fitting of tray or ladder
3. Support position under adjacent straight length

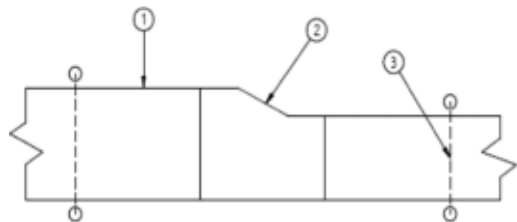

Figure 22e
Reducer support

2.8 Accessories

An accessory is a component used for supplementary function such as cable retention, covers and dividers etc.

2.8.1 Dividers

Dividers are used to physically separate different types or groups of cable within one cable ladder or cable tray run. The divider is usually manufactured from the same material as the cable ladder or cable tray onto which it is installed.

Dividers should be installed prior to the cable being laid and then fastened using the fixings recommended by the manufacturer.

2.8.2 Covers

Covers provide mechanical and environmental protection for cables being carried by cable ladder or cable tray, can be closed or ventilated and should be fitted in accordance with the manufacturer's instructions.

2.9 Site modification

2.9.1 General

No installation will be perfect and at sometime it may become necessary to cut the cable ladder or cable tray during installation. Care must be taken to ensure that all modifications made on site to cable ladder or cable tray are performed by competent personnel only.

2.9.2 Repair of damaged surfaces

Cable ladders or cable trays that have been hot dip galvanized after manufacture will need to be repaired after cutting, drilling and de-burring. Cutting operations leave bare metal edges that will begin to corrode immediately. Cable ladder and cable tray made from mill galvanized steels do not need to be repaired because they are not designed to be used in heavily corrosive atmospheres and have bare metal edges inherent in their design.

Repairing a galvanized finish must be done in accordance with BS EN ISO 1461 usually using a zinc rich paint. Other protective coatings that are cut or damaged must be repaired with compatible coatings.

2.10 Earth protection and EMC

2.10.1 Protection of cables

Cable ladder and cable tray systems are designed to provide continuous support to any cables installed upon them. Due to the fact that cable ladders and cable trays are never really fully enclosed they do not offer complete mechanical and environmental protection. For this reason unsheathed, single insulated power cables should not be installed on cable ladder and cable tray. Cable installed on cable ladder and cable tray should have some form of mechanical protection in the form of PVC sheathing, steel wire armouring or a copper covering (MICC).

Where moisture may be present, copper covered cables must also be PVC Sheathed to avoid electrochemical corrosion between the copper and a metallic cable support system.

2.10.2 Electrical continuity

Cables mounted on metal cable ladder and cable tray systems will normally be equivalent to either a Class I construction (e.g. mineral insulated cables without an overall PVC covering) or a Class II equivalent construction (e.g. PVC insulated and sheathed cable). Therefore, a metal cable ladder and cable tray system need not be purposely earthed unless used as a protective conductor, BS 7671 Regulation 543.2.1 refers.

Unless the metal cable ladder and cable tray system is liable to introduce a potential that does not already exist in the location, (generally earth potential) it will not meet the definition of an extraneous- conductive-part. Therefore, it would normally not be required to be connected to either a protective bonding conductor or any supplementary bonding conductor.

When required, metal cable ladder and cable tray systems should have adequate electrical continuity to ensure equipotential bonding and connections to earth. Manufacturers are required by BS EN 61537 to declare whether or not their systems are classified as having electrical continuity characteristics.

Installations shall comply with the requirements of BS 7671 (The Wiring Regulations).

2.10.3 EMC

Cable ladder and cable tray systems on their own are passive in respect of electromagnetic influences. The installation of current carrying cable however, may cause electromagnetic emissions that may influence information technology cables. As a guide for the installation of IT cables it is recommended that BS EN 50174-2 is consulted.

Installation of Cable



2.11 Preparation

Prior to installing cable in the tray or ladder, examine the cable paths to ensure all areas are free of debris that may interfere with the cable's installation. Surface areas of tray or ladder components likely to come into contact with cables shall not cause damage to the cables when installed according to the manufacture's instruction or this guide

Cable tray or cable ladder should never be used as a walkway.

2.12 Wiring Regulations

The installation of cables shall meet the requirements of BS 7671 (The Wiring Regulations) or other national requirements as applicable.

2.13 Power Cables

2.13.1 Pulling Considerations

Where cables are large or cable runs are long, their installation may require pulling tools (Figures 23 and 24); in such cases the following is recommended.

- On horizontal straight runs, the cables generally ride on rollers mounted in or on the cable tray or cable ladder (Figure 23a). These rollers should be properly spaced dependent on the size and weight of the cable to prevent the cable from sagging and dragging in the cable tray or cable ladder during the pull. Contact the cable manufacturer for information regarding proper roller spacing.

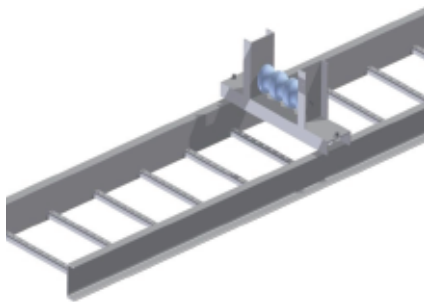

Figure 23a
Straight Roller

Figures 23
Cable guides for pulling cables

- On horizontal bends and vertical pulls, the cables are generally run through rollers or pulleys to maintain a minimum bending radius (Figures 23b and 23c). Rollers and pulleys must be of sufficient diameter to prevent pinching the cable between the roller/ pulley flanges. Each cable will have a minimum bending radius that must be maintained to prevent damage to the cable. Information on cable bending radii can be obtained from Table I. Multiple pulling tools may be required at one bend to maintain this radius. Care should be taken with the entry and exit angle of the cable at the pulling tool, as this angle can exceed the bending radius.
- Due to the length of some cable pulls and the cable weight, a great deal of force can be applied to the pulleys on horizontal and vertical bends. These pulleys should be anchored to the structural steel and not to the cable tray or cable ladder due to the force that can be applied during pulling. Do not pull down on the horizontal rollers, as they are not designed for this purpose, and damage could result to the cable, cable tray or cable ladder.

Figures 23
Cable guides
for pulling
cables



Figure 23b
90° Roller

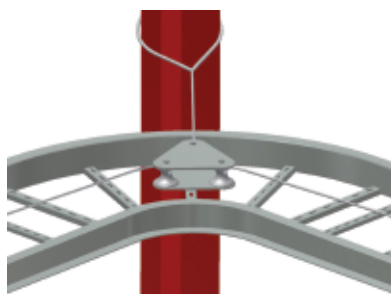

Figure 23c
Pulley Guide

Table I Minimum internal bending radii of bends in cables for fixed wiring

Insulation	Finish	Overall diameter *	Factor to be applied to overall diameter of cable to determine minimum internal radius of bend
Thermosetting or thermoplastic (circular, or circular stranded copper or aluminium conductors)	Non-armoured	Not exceeding 10 mm	3(2)†
		Exceeding 10 mm but not exceeding 25 mm	4(3)†
		Exceeding 25 mm	6
	Armoured	Any	6
Thermosetting or thermoplastic (solid aluminium or shaped copper conductors)	Armoured or non- armoured	Any	8
Mineral	Copper sheath with or without covering	Any	6‡
Flexible cables	Sheathed	Any	No specific provision but no tighter than equivalent sized non-armoured cable**

* For flat cable the diameter refers to the major axis.

† The figure in brackets relates to single-core circular conductors of stranded construction installed in conduit, ducting or trunking.

‡ For mineral insulated cables, the bending radius shall normally be limited a minimum of 6 times the diameter of the bare copper sheath, as this will allow further straightening and reworking if necessary. However, cables may be bent to a radius not less than 3 times the cable diameter over the copper sheath, provided that the bend is not reworked.

** Flexible cables can be damaged by too tight or repeated bending.

Note Table I (equivalent to Table G.2) extracted from 'Guidance Note I Selection and Erection' to BS 7671

2.13.2 Pulling the cable

Larger cables will usually require a pulling sock (basket grip) and/or pulling eye to be attached to the leading end of the cables metallic conductor(s). If the cable does not have a pulling eye attached by the manufacturer, the cable manufacturer should be contacted for information on field installation of a pulling sock and/or pulling eye (Figures 24a and 24b). Where pulling attachments are used on the conductors, they should be covered with protective tape or similar to prevent scoring of the cable trays, cable ladders and installation pulleys.

Cables generally have pulling tension restrictions, so a dynamometer may be installed at the pulling end in order to ensure that the cable's maximum pulling tension is not exceeded. The cable should be pulled at a constant speed. The maximum pulling tension and cable pulling speed cable can be obtained from the cable manufacturer. Cables should be placed and not dropped in to the cable tray or cable ladder.

Figures 24
Cable pulling
tools



Figure 24a
Cable pulling sock

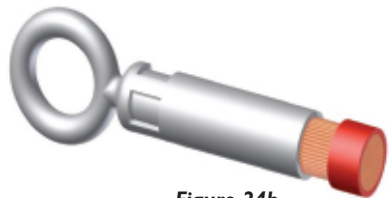

Figure 24b
Cable pulling eye

2.13.3 Fastening

- Cables should be fastened to the cable ladder and/or cable tray using cable cleats or cable ties to prevent movement of the cables under normal use and during fault conditions (Figures 25a and 25b). Generally the spacing between cable fastenings should not exceed the dimensions stated in Table 2. For some applications where the fault current level requires it, spacing between cable fastenings may be less than those stated in Table 2. Where this applies details should be obtained from the electrical installation designer and/or the supplier of the fastenings. Cable cleats and cable ties should be correctly sized and only tightened enough to secure the cable without indenting the insulation sheath.
- On vertical runs the fastenings must be able to withstand the forces exerted by the weight of the cable. The cable weight should be supported in such a manner as to prevent damage to the cable ladder, cable tray or cable.

- Where possible it is best practice to position cable cleats on alternate rungs of the cable ladder in order to evenly spread the load along the length of the cable ladder as illustrated in Figure 25a.

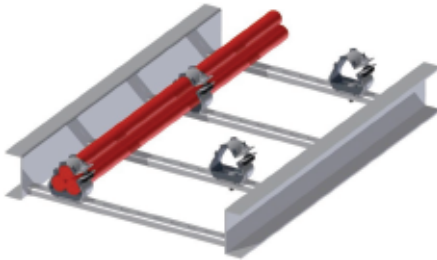

Figure 25a
Cable attached to ladder
using cable cleats

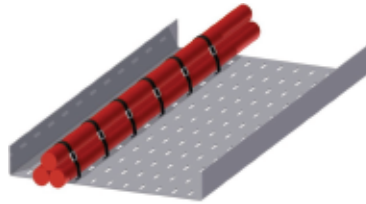

Figure 25b
Cable attached to tray
using cable ties

Figures 25
Cable
fastening
devices

Table 2 Spacings of supports for cables in accessible positions

Maximum spacings of clips (mm)								
Overall diameter of cable, d* (mm)	Non-armoured thermosetting or thermoplastic (PVC) sheathed cables				Armoured cables		Mineral insulated copper sheathed or aluminium sheathed cables	
	Generally		In caravans		Horizontal† 6	Vertical† 7	Horizontal† 8	Vertical† 9
1	Horizontal† 2	Vertical† 3	Horizontal† 4	Vertical† 5				
d≤9	250	400	250 (for all sizes)	400 (for all sizes)	-	-	600	800
9<d≤15	300	400			350	450	900	1200
15<d≤20	350	450			400	550	1500	2000
20<d≤40	400	550			450	600	-	-

Note: For the spacing of supports for cables having an overall diameter exceeding 40 mm, the manufacturer's recommendation should be observed.

* For flat cables taken as the dimension of the major axis.

† The spacings stated for horizontal runs may be applied also to the runs at an angle of more than 30° from the vertical. For runs at an angle of 30° or less from the vertical, the vertical spacings are applicable.

Note Table 2 (equivalent to Table 4A) extracted from the Onsite Guide to BS 7671

2.14 Data Cables

2.14.1 Installation

There are some general rules that apply to the installation of all data cable bundles, regardless of containment type, and they are:

Cable ties must not be too tight. Any cable within a tied bundle must be able to be moved through that tie with slight resistance. Data and optical cables cannot stand the same heavy-duty 'lashing' as power cables. The tie must not be too thin as it may cut into the sheath of the cable.

The minimum bend radius shall not be less than that specified by the cable manufacturer. Manufacturers generally specify six to eight times the cable diameter as the cable bend radius.

There is no exact or correct figure for the amount of cables allowed in any one bundle, typically a figure of between 24 and 48 cables is used.

2.14.2 Segregation

Where power and data cables are installed within the same containment system or within close proximity to each other, suitable segregation shall be used. Guidance on segregation can be found from BS 6701 and BS EN 50174.

2.15 Expansion

Where expansion joints are present in the cable tray or cable ladder installation, provision must be made for the cable to expand and contract correspondingly. This is usually achieved with a loop in the cable at the expansion joint position.

2.16 Electro Mechanical Effects

Electrical Short Circuits

When an electrical short circuit occurs under fault conditions the current that flows can in some instances reach tens of thousands of amps which can last from a few milliseconds to several seconds depending on the electrical installation requirements. Such short circuit currents produce high magnetic fields which can interact to produce large mechanical forces. These forces can cause significant displacement of the cables and therefore some form of restraint must be provided to prevent damage to the cables. For large diameter cables the most common form of restraint is by the use of cable cleats which hold the cables to the cable ladder or cable tray. Some of the force may therefore be transferred to the cable ladder or cable tray via the cable cleat, and could be sufficient to cause damage to the ladder or tray.

The calculation of the forces is complex and the effect on a cable ladder or cable tray can only be fully determined by testing. See photographs below showing the effects of testing.

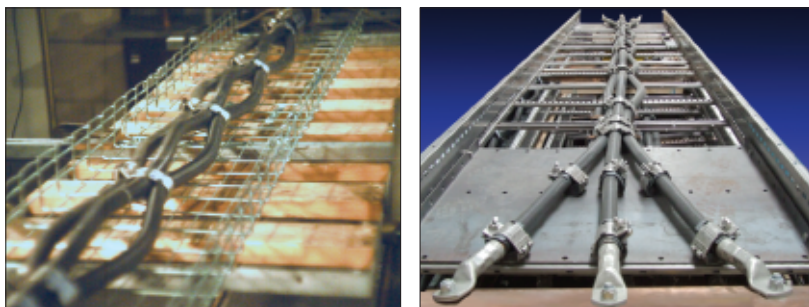

Displacement of cables when subjected to high short circuit currents

Where such large electrical fault currents could possibly occur then the cable ladder/cable tray/cable cleat manufacturers should be consulted.

For reference the calculation of the forces between two conductors can be carried out using the formula given in BS EN 61914:2009:

$$F = \frac{0.17 \times (i_p)^2}{S}$$

Where:

F = force in $N\ m^{-1}$

i_p = peak prospective short circuit current in kA

S = spacing between the conductors in m

However the 'F Value' is the force within the 'loop' of the cleat and does not indicate how much of this force transfers into the structure, or containment, which the cleat is fastened to. Hence the only certain way to assess that the cable support system is strong enough to resist the mechanical force is by testing.

SECTION 3

Environment



3.1 Selecting the right material and finish

3.1.1 Preventing corrosion

In planning any cable ladder or cable tray installation the choice of an appropriate corrosion resistant material and finish is always a key issue at the specification stage. The correct choice has long term implications and is crucial for ensuring the longevity and the aesthetics of the complete installation.

Maintenance against corrosion of cable ladder and cable tray installations is generally impractical. It is vital at the specification stage that the selected finish for the equipment is capable of providing lifetime protection from corrosion within the intended environment, ideally with some margin of safety. Therefore it is important to establish the corrosive properties of an environment to ensure the right material and finish is chosen.

The following sub-sections give information on how corrosion occurs and contain supporting technical data on the standard construction materials and surface finishes available. Consult the manufacturer for further information.

3.1.2 Chemical corrosion

Few metals will suffer corrosion damage in a dry, unpolluted atmosphere at a normal ambient temperature. Unfortunately such environments are exceptional and atmospheric pollutants as well as moisture is likely to be present to some degree in most situations, thus some chemical corrosion may be expected in almost all situations.

Any support installation situated in an area where higher concentrations of chemicals exist must be subject to more detailed consideration in order to select an appropriate finish which provides the best combination of initial cost and expected life.

3.1.3 Electrochemical corrosion

When two dissimilar metals are in contact and become damp it is possible for corrosion to be induced in one of the metals. Such corrosion may progress rapidly and cause considerable damage so it is important to consider and, if necessary, take steps to eliminate this process.

Electrochemical (alternatively referred to as electrolytic or bimetallic) corrosion takes place because the two different metals each behave as electrodes and the moisture acts as the electrolyte as in a simple battery; as with any battery the resulting flow of current will cause corrosion of the anode.

The likely effects of this reaction can be predicted using the Galvanic Series.

3.1.4 Galvanic series

The rate of corrosion depends upon the differences in electrical potential of the metals as defined by the Galvanic Series (Figure 26). The strength of the electrolyte, the period for which the electrolyte is present, and the geometry of the connection between the dissimilar metals are all influencing factors. When corrosion occurs it is the anodic metal (which is higher in the galvanic series) which will corrode in preference to the cathodic metal (which is lower in the galvanic series).

The best way to prevent electro-chemical corrosion is to ensure that all system components have the same finish e.g. all components HDG or all components stainless steel. Where this is not possible then components with a low potential difference, as shown in Table 3, should be used.

Even when two dissimilar metals are in moist contact, electrochemical corrosion need not necessarily take place. Its likelihood depends upon the potential difference between the two metals; this can be obtained by taking their respective values from the Galvanic Series chart shown in Figure 26 and subtracting one from the other. When the potential difference is less than the values given in Table 3, corrosion is unlikely to occur.

If from consideration of the Galvanic Series excessive corrosion does appear likely then the risk can be largely eliminated by insulating the dissimilar metals from one another, breaking the electrical path between them. A layer of paint or grease on either surface is sometimes used but is not recommended because it only offers a short term solution. A better solution is to electrically isolate them by using an insulating material such as polypropylene, nylon or other non-conductive material, usually in the form of pads or washers.

In addition to the contact between dissimilar metals the relative surface areas between them also has an effect. If the anodic metal has a small surface area in relation to its counterpart it will be corroded very aggressively and any sacrificial protection it provides may be short lived. If on the other hand it has a large surface area in comparison to its less reactive counterpart, some minor corrosion may take place at points of contact but the process is likely to reach equilibrium rapidly so that any further reaction is insignificant as in the following example.

Consider the example of a tray or ladder with a thick protective zinc coating over a large area connected together using stainless steel fixings each having a small surface area. The stainless steel, in contact with the galvanizing, causes only minor corrosion of the zinc because of the small area of the stainless steel fixing in comparison with the much larger surface area of the zinc coating.

For further details on electrochemical corrosion see PD 6484 'Commentary on corrosion at bimetallic contacts and its alleviation.'

If copper is laid directly onto a galvanized surface the zinc will rapidly corrode. Thus cables should always have an insulating sheath if they are to be installed on galvanized cable ladder or tray.

Table 3
Limiting electrical potential differences to minimise corrosion effects

Environment	Maximum potential difference
Marine and outdoor	0.3 volts
Indoor	0.5 volts
Indoor, hermetically sealed (dry)	No restriction ^{a)}
a) With no moisture to act as the electrolyte no electrochemical corrosion can take place.	

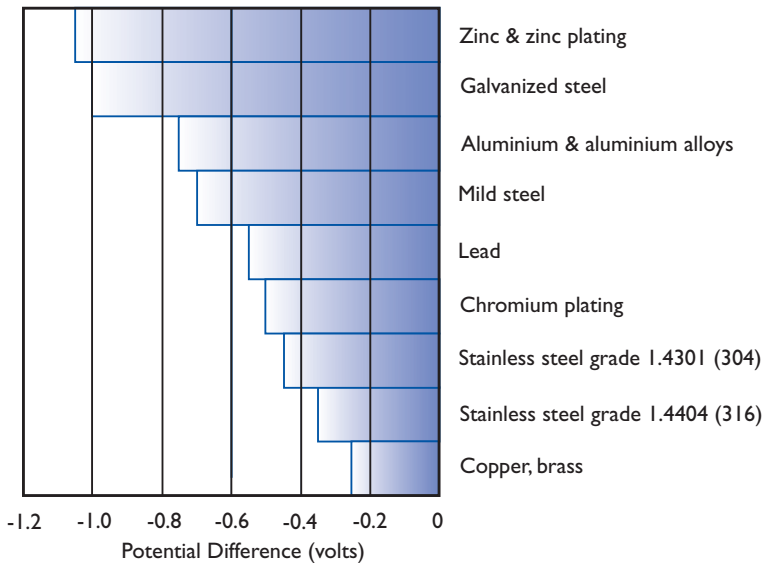

Figure 26
Galvanic Series Chart

The galvanic series illustrates the potential difference between a section of metal and a calomel electrode when both are immersed in sea water at 25 °C

3.1.5 The merits of zinc

The Galvanic Series Chart clearly indicates why zinc is such a useful corrosion resistant coating for mild steel.

Firstly it forms an impervious zinc barrier around the steel, coating it with a metal whose own rate of chemical corrosion is both low and predictable in most situations.

Secondly, if the coating is damaged at any point (e.g. at a cut edge) the zinc surrounding the damaged area becomes the anode of the electrolytic cell and is sacrificially corroded away very slowly in preference to the underlying steel. Corrosion products from the zinc may also be deposited onto the steel, effectively re-sealing the surface and maintaining the integrity of the barrier. This ensures the strength of the steel structure remains unaffected.

Because zinc appears near the top of the Galvanic Series it will act as a sacrificial anode in relation to most other metals; thus its relatively low cost and the ease with which it can be applied as a galvanized coating on steel means that it continues to be the most commonly specified protective finish for support systems.

Steel cable ladder or cable tray systems can usually be assigned to one of the following corrosion classes as shown in Table 4 and a suitable zinc coating system selected from Table 5 to achieve the required life expectancy of the coating.

Table 4
Description
of typical
atmospheric
environments
related to the
estimation
of corrosivity
categories

Corrosivity category C Corrosion rate for zinc (based upon one year exposures), r_{corr} ($\mu\text{m.a}^{-1}$) and corrosion level	Typical environments (examples)	
	Indoor	Outdoor
C1 $r_{\text{corr}} \leq 0.1$ Very low	Heated spaces with low relative humidity and insignificant pollution, e.g. offices, schools, museums	Dry or cold zone, atmospheric environment with very low pollution and time of wetness, e.g. certain deserts, central Arctic/Antarctica
C2 $0.1 < r_{\text{corr}} \leq 0.7$ Low	Unheated spaces with varying temperature and relative humidity. Low frequency of condensation and low pollution, e.g. storage, sport halls	Temperate zone, atmospheric environment with low pollution ($\text{SO}_2 < 5 \mu\text{g}/\text{m}^3$), e.g.: rural areas, small towns. Dry or cold zone, atmospheric environment with short time of wetness, e.g. deserts, sub-arctic areas
C3 $0.7 < r_{\text{corr}} \leq 2$ Medium	Spaces with moderate frequency of condensation and moderate pollution from production process, e.g. food-processing plants, laundries, breweries, dairies	Temperate zone, atmospheric environment with medium pollution ($\text{SO}_2: 5 \mu\text{g}/\text{m}^3$ to $30 \mu\text{g}/\text{m}^3$) or some effect of chlorides, e.g. urban areas, coastal areas with low deposition of chlorides, subtropical and tropical zones with atmosphere with low pollution
C4 $2 < r_{\text{corr}} \leq 4$ High	Spaces with high frequency of condensation and high pollution from production process, e.g. industrial processing plants, swimming pools	Temperate zone, atmospheric environment with high pollution ($\text{SO}_2: 30 \mu\text{g}/\text{m}^3$ to $90 \mu\text{g}/\text{m}^3$) or substantial effect of chlorides, e.g. polluted urban areas, industrial areas, coastal areas without spray of salt water, exposure to strong effect of de-icing salts, subtropical and tropical zones with atmosphere with medium pollution
C5 $4 < r_{\text{corr}} \leq 8$ Very high	Spaces with very high frequency of condensation and/or with high pollution from production process, e.g. mines, caverns for industrial purposes, unventilated sheds in subtropical and tropical zones	Temperate and subtropical zones, atmospheric environment with very high pollution ($\text{SO}_2: 90 \mu\text{g}/\text{m}^3$ to $250 \mu\text{g}/\text{m}^3$) and/or important effect of chlorides, e.g. industrial areas, coastal areas, sheltered positions on coastline
CX $8 < r_{\text{corr}} \leq 25$ Extreme	Spaces with almost permanent condensation or extensive periods of exposure to extreme humidity effects and/or with high pollution from production process, e.g. unventilated sheds in humid tropical zones with penetration of outdoor pollution including airborne chlorides and corrosion-stimulating particulate matter	Subtropical and tropical zones (very high time of wetness), atmospheric environment with very high pollution (SO_2 higher than $250 \mu\text{g}/\text{m}^3$), including accompanying and production pollution and/or strong effect of chlorides, e.g. extreme industrial areas, coastal and offshore areas with occasional contact with salt spray

- NOTE 1** Deposition of chlorides in coastal areas is strongly dependent on the variables influencing the transport inland of sea-salt, such as wind direction, wind velocity, local topography, wind sheltering islands beyond the coast, distance of the site from the sea, etc.
- NOTE 2** Extreme influence of chlorides, which is typical of marine splashing or heavy salt spray, is beyond the scope of ISO 9223.
- NOTE 3** Corrosivity classification of specific service atmospheres, e.g. in chemical industries, is beyond the scope of ISO 9223.
- NOTE 4** Sheltered and not rain-washed surfaces, in a marine atmospheric environment where chlorides are deposited, can experience a higher corrosivity category due to the presence of hygroscopic salts.
- NOTE 5** In environments with an expected “CX category”, it is recommended to determine the atmospheric corrosivity classification from one year corrosion losses. ISO 9223 is currently under revision; category “CX” will be included in the revised document.
- NOTE 6** The concentration of sulfur dioxide (SO₂) should be determined during at least 1 year and is expressed as the annual average.
- NOTE 7** Detailed descriptions of types of indoor environments within corrosivity categories C1 and C2 is given in ISO 11844-1. Indoor corrosivity categories IC1 to IC5 are defined and classified.
- NOTE 8** The classification criterion is based on the methods of determination of corrosion rates of standard specimens for the evaluation of corrosivity (see ISO 9226).
- NOTE 9** The thickness-loss values are identical to those given in ISO 9223, except that, for rates of 2 µm (per year) or more, the figures are rounded to whole numbers.
- NOTE 10** The zinc reference material is characterised in ISO 9226.
- NOTE 11** Corrosion rates exceeding the upper limits in category C5 are considered as extreme. Corrosivity category CX refers to specific marine and marine/industrial environments.
- NOTE 12** To a first approximation, the corrosion of all metallic zinc surfaces is at the same rate in a particular environment. Iron and steel will normally corrode 10 to 40 times faster than zinc, the higher ratios usually being in high-chloride environments. The data is related to data on flat sheet given in ISO 9223 and ISO 9224.
- NOTE 13** Change in atmospheric environments occurs with time. For many regions, the concentrations of pollutants (particularly SO₂) in the atmosphere have reduced with time. This has led to a lowering of the corrosivity category for these regions. This has, in turn, led to the zinc coatings experiencing lower corrosion rates compared to historical corrosion performance data. Other regions have experienced increasing pollution and industrial activity and therefore would be expected to develop environments more accurately described by higher corrosivity categories.
- NOTE 14** The corrosion rate for zinc and for zinc-iron alloy layers are approximately the same.

Note: Table 4 extracted from BS EN ISO 14713-1:2009

Table 5

Life to first maintenance for a selection of zinc coating systems in a range of corrosivity categories

System	Reference standard	Minimum thickness µm	Selected corrosivity category (ISO 9223) life min./max. (years) and durability class (VL, L, M, H, VH)							
			C3		C4		C5		CX	
Hot dip galvanizing	ISO 1461	85	40/>100	VH	20/40	VH	10/20	H	3/10	M
		140	67/>100	VH	33/67	VH	17/33	VH	6/17	H
		200	95/>100	VH	48/95	VH	24/48	VH	8/24	H
Hot dip galvanized sheet	EN 10346	20	10/29	H	5/10	M	2/5	L	1/2	VL
		42	20/60	VH	10/20	H	5/10	M	2/5	L
Hot dip galvanized tube	EN 10240	55	26/79	VH	13/26	H	7/13	H	2/7	L
Sheradizing	EN 13811	15	7/21	H	4/7	M	2/4	L	1/2	VL
		30	14/43	VH	7/14	H	4/7	M	2/4	VL
		45	21/65	VH	11/25	H	6/11	M	3/6	L
Electrodeposited sheet	ISO 2081	5	2/7	L	1/2	VL	1/1	VL	0/1	VL
		25	12/36	H	6/12	M	3/6	M	1/3	VL
Mechanical plating	ISO 12683	8	4/11	M	2/4	L	1/2	VL	0/1	VL
		25	12/36	H	6/12	M	3/6	L	1/3	VL

NOTE 1 The figures for life have been rounded to whole numbers. The allocation of the durability designation is based upon the average of the minimum and maximum of the calculated life to first maintenance, e.g. 85µm zinc coating in corrosivity category C4 (corrosion rate for zinc between 2.1µm per annum and 4.2µm per annum), gives expected durability of $85/2.1 = 40.746$ years (rounded to 40 years) and $85/4.2 = 20.238$ years (rounded to 20 years). Average durability of $(20 + 40)/2 = 30$ years – designated “VH”.

NOTE 2 Life to first maintenance of protective coating systems: The list of systems given in this table, classified by environment and typical time to first maintenance, indicates the options open to the specifier. The recommended treatments listed for longer lives will always protect for shorter periods and are often also economical for these shorter periods.

NOTE 3 This table can be applied to any zinc coating to determine the life to first maintenance. The corrosion rate for any given environment is indicated by the corrosivity classification category, C3 to CX. The minimum and maximum life to first maintenance for the selected system is set out in the body of this table.

NOTE 4 It is impossible to achieve an exactly uniform thickness of any type of coating. The third column of this table indicates the minimum average coating thickness for each system. In practice, the overall mean is likely to be substantially in excess of this minimum, which is important as the zinc coatings are able to provide protection to adjacent areas which can lose their coating prematurely.

NOTE 5 It should be noted that thickness requirements in EN 10240 are minimum local thickness requirements. Furthermore, the thickness quoted for coatings in these tables may not match specified coating thicknesses in some standards.

NOTE 6 In this table, guidance is given for coatings applied to structural and cold-forming grades of hot dip galvanized sheet and cold-rolled sections, on zinc electroplated sheet, on coatings thermally sprayed with zinc, on mechanically plated coatings, on sherardized coatings and for articles hot dip galvanized after manufacture. Hot dip galvanized fabricated and semi-fabricated products made from thin material and fasteners and other centrifuged work usually have intermediate thicknesses of coating (see also relevant product standards). As the life of all zinc coatings is approximately proportional to the thickness or mass of zinc coating present, the relative performance of such intermediate thicknesses can readily be assessed.

NOTE 7 Zinc/aluminium alloy coatings (with 5 % to 55 % aluminium) usually last longer than pure zinc; pending wider use, they are not included in this table. There is widespread technical literature available on these classes of materials.

NOTE 8 Thickness of hot dip galvanizing on products: ISO 1461 specifies the standard hot dip galvanized coating at the equivalent of 85µm minimum for steel > 6 mm thick. Thinner steel, automatically hot dip galvanized tubes and centrifugal work (usually threaded work and fittings) have thinner coatings, but these are usually greater than 45µm. Where it is desired to use coatings of different thicknesses to those stated, their lives can be ascertained by calculation; the life of a zinc coating is (to a first approximation) proportional to its thickness. For tubes, EN 10240 includes an option for the purchaser to specify a thicker coating requirement which will give an extended service life. Hot dip galvanized coatings thicker than 85µm are not specified in ISO 1461 but the general provisions of that International Standard apply and, together with specific thickness figures, may form a specification capable of third-party verification. It is essential to know the composition of the steel to be used and the galvanizer should be consulted before specifying, as these thicker coatings may not be available for all types of steel. Where the steel is suitable, thick coatings may be specified.

NOTE 9 Thickness of sherardizing on products: EN 13811 specifies coating thickness of 3 classes up to 45µm, but for special applications a higher thickness may be appropriate. Thicker coatings up to 75µm can be considered. The sherardizer should be consulted where thicker coatings are required, as a thicker coating may not be available for all types of steel.

NOTE 10 Thermal spray coatings. These coatings are normally used as part of a corrosion protection system after receiving a sealing coat. The performance of the coating system is highly dependent upon this being carried out effectively. No data is provided for performance in this part of ISO 14713. Further guidance can be found in EN 15520.

Note: Table 5 extracted from BS EN ISO 14713-1:2009

3.2 Finishes

3.2.1 Hot Dip Galvanizing (HDG)

Hot dip galvanizing after manufacture is an excellent, economical protective finish used on support systems in many industrial and commercial applications.

The galvanized coating is applied as a final manufacturing process by immersing a steel component (after various pre-treatments) in a large bath of molten zinc; the zinc forms an alloy with this the steel substrate and protects the steel from corrosion as above.

The life of a zinc coating is directly proportional to its thickness but in different environments this life does vary. However, because hot dip galvanizing has been used for many years its life in diverse environments has been well established. The most comprehensive guide to the design life of zinc coated systems in different environments is contained in BS EN ISO 14713-1 Zinc coatings: General principles of design and corrosion resistance (see Tables 4 and 5).

In the presence of certain atmospheric pollutants (such as sulphur dioxide in industrial areas) or when installed in an aggressive coastal or marine environment the rate of dissipation of the zinc will be accelerated; however in most situations hot dip galvanizing remains an extremely effective and economical corrosion resistant finish.

BS EN ISO 1461 provides the specification for a hot dip galvanized coating. Heavier gauges of steel will usually take up a thicker coating of zinc than lighter gauges so the standard defines the coating for different steel gauges. The coating thicknesses given in the standard is shown in Table 6.

Table 6
Steel and
zinc coating
thickness

Steel thickness mm	Minimum average zinc thickness µm (microns)
Less than 1.5	45
1.5 up to and including 3	55
Greater than 3 up to and including 6	70
Greater than 6	85

Note details extracted from BS EN ISO 1461

3.2.2 Deep Galvanizing

A Deep Galvanized finish has all of the characteristics of hot dip galvanizing (HDG) but with a much thicker coating of zinc. This can give up to 3 times the life of the standard hot dip galvanized (BS EN ISO 1461) finish in certain environments.

Although the appropriate British Standard for Deep Galvanizing is BS EN ISO 1461 (the same as for hot dip galvanizing after manufacture) the process requires the use of steel containing a slightly higher proportion of silicon. When galvanizing normal mild steel the process effectively ceases after a short immersion time in the galvanizing bath which gives, depending on the gauge of the steel, the coating thicknesses laid down within BS EN ISO 1461. However, with silicon bearing steels the chemistry of the galvanizing process changes, resulting in the zinc coating continuing to increase in thickness as long as the steel remains immersed in the zinc.

Coatings of up to three times as thick as the minimum requirements of BS EN ISO 1461 are both possible and practical to achieve. However, in practice the most cost effective coating thickness is usually twice the thickness required by BS EN ISO 1461.

3.2.3 Pre-galvanized (PG)

A zinc coating can be economically applied to steel sheet immediately after its manufacture; the result, pre-galvanized steel (to BS EN 10346) can be an attractive, bright material which is suitable for non-arduous environments.

Pre-galvanized (or mill galvanized) steel is produced by unwinding steel coil and passing it continuously through a bath of molten zinc and then past air jets to remove excess zinc from the surface. The process is closely controlled to produce a thin, even and ripple free zinc coating with very few imperfections. Because this pre-galvanized steel coil must then be cut to shape during subsequent manufacture of support equipment, the edges of the finished components will have no zinc coating. This aspect, together with the relatively light zinc coating provided by the process, make pre-galvanized service supports suitable for indoor, low-corrosive environments (particularly where an aesthetically attractive appearance is important) but unsuitable for humid indoor or outdoor applications.

3.2.4 Electroplating with zinc

This coating process is often referred to as bright zinc plating (BZP).

Electroplating with zinc may be used when a smooth bright decorative finish is required. Parts can be coloured or colourless depending on the type of passivation process used. It is generally used for internal applications where a low degree of corrosion resistance is acceptable.

Electroplating involves connecting the metal substrate to a negative terminal of a direct current source and another piece of metal to a positive pole, and immersing both metals in a solution containing ions of the metal to be deposited, in this case zinc.

3.2.5 Zinc Whiskers

The phenomenon of zinc whiskers (Figure 27 and Table 7) has been a known issue for more than 60 years and was initially associated with access floor tiles that have a metal zinc coated base, used in the electronics and communications industries. Although the existence of zinc whiskers is widely acknowledged, there have been no reported instances of equipment failure attributed to zinc whiskers on cable management systems. Zinc whiskers are conductive crystalline structures that sometimes unpredictably grow outward from a zinc coated surface.

Over periods that may take many months or even years, zinc-coated surfaces may begin to exhibit hair-like filaments from the surface which grow by adding zinc atoms at the root of these metal crystals. The lengths, thicknesses, rates of growth, and population densities of zinc whiskers can be highly variable from sample to sample.

The process of zinc whisker growth is not fully understood, however, available information would suggest that compressive stresses within the coating are a key factor in their formation. It is believed that compressive stresses within a hot dipped galvanized coating after manufacture are inherently lower than in pre-galvanized and/or zinc plated coatings.

Whilst certain 'organic' coatings which can be applied over the zinc surface may delay whisker growth, there is no evidence that the coating will prevent the formation of whiskers.

Some typical attributes of zinc whiskers are as follows:

- **Length:** Often up to a few millimetres but rarely in excess of 1 centimetre,
- **Thickness:** Typically a few microns, but spanning a range from less than 1 micron to >30 microns. For comparison, zinc whiskers may be < 1/100th the thickness of a human hair,
- **Rate of growth:** Up to 1 millimetre in length per year,
- **Incubation:** Recorded from a matter of months to many years,
- **Density of growth (number of whiskers per area) spans a very wide range:**
 - sparse growths approach 1 whisker per square centimetre
 - very dense growths may exceed 1000 whiskers per square centimetre



Figure 27
Microscopic image of zinc whiskers (image courtesy of the NASA Electronic Parts & Packaging Program)

Experience suggests that it is extremely rare that zinc whiskers will form on a hot dipped galvanized coating applied after manufacture. However, if the risk of zinc whiskers on a new installation is to be absolutely avoided then the following alternative materials may be specified:

- Stainless steel,
- mild steel with a protective organic coating,
- non-metallic.

Due consideration must also be given to the supports, brackets, fixings & fasteners.

Should there be a concern over zinc whiskers on an existing installation, contact the manufacturer whose product is installed. In some instances it may be necessary to instigate a periodic inspection and audit of the installation in order to determine any corrective actions.

3.2.6 Zinc flakes

These are associated with the process of hot dip galvanizing after manufacture. They are small zinc films usually formed in perforations, however, during the final finishing process, storage and transportation most zinc flakes become detached from the product, (see Table 7). Unlike zinc whiskers, due to their size and mass, zinc flakes do not readily become airborne and are therefore unlikely to enter and cause damage to electrical equipment. There are no known reported instances of zinc flakes causing failure of electrical equipment.

Table 7
Susceptibility
to zinc
whiskers /
zinc flakes
by finish

Type of Finish	Zinc Whiskers	Zinc Flakes
Zinc plated	Possible	None
Pre-galvanized	Possible	None
Hot dip galvanized	Extremely rare	Some
Stainless steel	None	None
Mild steel with organic coating	None	None
Non-metallic	None	None

3.2.7 Other applied finishes

Powder coating may be applied as a protective finish but more generally it is requested as a decorative layer applied to systems already protected by a zinc coating.

3.2.8 Stainless Steel

For most practical purposes stainless steel can be regarded as maintenance free and suffering no corrosion. Inevitably there is a relatively high price to pay for these attractive properties but, in aggressive environments or where the cost or inconvenience of gaining subsequent maintenance access is prohibitive, this initial cost premium may well be justified.

Stainless steel contains a high proportion of chromium (usually at least 11%) and the steel's remarkable immunity to corrosive attack is conferred by the chromium-rich oxide film which occurs naturally on its surface. This invisible film is not only inert and tightly bonded to the surface; it also re-forms quickly if the surface is damaged in any way. The fire resistance of stainless steel is particularly noteworthy; tests have demonstrated that stainless steel cable supports can be expected to maintain their integrity for considerable periods even when exposed to direct flame temperatures exceeding 1,000°C. This may be an important consideration where the electrical circuits being supported provide for emergency power or control systems.

Stainless steel is also used where hygiene is a major consideration. Its advantages in such applications are again its excellent resistance to the various chemicals and washes which are frequently used for cleaning purposes and the smoothness of surface (depending on the finish specified) which minimises the soiling or contamination that can take place.

Many grades of stainless steel are available but the one generally used in aggressive marine environments is BS EN 10088 Grade 1-4404 (equivalent to 316L31, BS 1449: Part 2). This grade has improved corrosion resistance (particularly in the presence of chlorides) and high temperature strength. It is often used in the chloride-laden marine conditions which exist on offshore installations and in coastal regions.

For less aggressive environments BS EN 10088 Grade 1-4301 (equivalent to 304, BS 1449: Part 2) is the normal grade. This grade may be used for aesthetic purposes and is commonly used in the dairy and food industries where cleanliness is of great importance. Final finishes with mechanical brushing or polishing are used to provide a good looking and robust surface finish.

A stainless steel surface will have excellent corrosion resistance due to the chromium oxide layer on the surface of the product. With some stainless steels however, the surface areas can become subject to corrosion due to the depletion of chromium during welding. To overcome this problem welded stainless steel products are often pickled and passivated after welding.

3.2.8.1 Pickling & Passivation

The pickling and passivation process gives optimum corrosion resistance and is carried out under a carefully controlled operation aimed at minimising risk to both the environment and individuals carrying out the process.

3.2.8.2 Pickling

The pickling process on the surface of stainless steel is carried out to remove a thin layer of metal from the surface of the component. Mixtures of nitric and hydrofluoric acid are usually used for this process. Pickling is also used to remove weld heat tinted layers from the surface of stainless steel where the steel's surface chromium level may have been reduced. Finally pickling can be used to remove carbon steel contamination which occurs on the component during the manufacture process and to reduce small areas around a weld which may be deprived of oxygen allowing localised forms of crevice or pitting attack to form corrosion.

3.2.8.3 Passivation

A passive chromium rich oxide film naturally forms on the surface of stainless steel. Additional passivation adds a thick oxidising passive layer that is accelerated and forms a thickened protective layer. Unlike pickling no metal is removed from the surface and the passivation always occurs after the pickling has been completed. This passivation treatment reduces the corrosion risk on stainless steel and leaves a Matt grey smooth finish.

3.3 Non-Metallic systems

3.3.1 uPVC (Unplasticised Polyvinyl Chloride)

uPVC cable trays offer a light weight corrosion resistant alternative to steel systems. uPVC typically contains corrosion resistant additives. This makes uPVC cable tray

resistant to chemical and aggressive agents such as hydrogen, benzene, liquid propane and methanol. In addition, cut or damaged edges do not corrode in adverse atmospheric conditions. However, the product's resistance to some chemicals can vary depending on the working temperature, so it is advisable to check the manufacturer's guidelines.

Whilst PVC cable trays are generally suitable for use at temperatures between -20°C and + 60°C, the products are subject to thermal expansion and contraction. Any holes drilled in the tray for screw or bolt fixings should be oversized to allow for movement due to temperature fluctuations and it is advisable that nylon washers are used under screw or bolt heads. Where required expansion gaps should be left at adequate intervals between lengths as recommended by the manufacturer.

3.3.2 GRP (Glass Reinforced Polymer)

Constructed from glass reinforced thermoset resins, GRP Cable Support Systems can be designed and manufactured to combine light weight properties with a structural integrity comparable with metallic systems.

GRP Cable Support Systems can be made to resist many corrosive environments and have non-conductive properties.

GRP Products can be produced by means of the pultrusion process or by moulding. The pultrusion process uses a combination of uni-directional and cross strand glass rovings and matting which is resin impregnated and pulled through a heated die to produce a very solid and structurally sound profile that is generally stronger than moulding. The pultrusion process is the one normally chosen to produce cable ladder and cable tray systems.

The resin that is used gives the final product different properties, the most common resins used are Polyester, Acrylic and Vinylester.

Polyester

This is the most common resin used, it offers good all-round protection against corrosion, has excellent mechanical strength and a good resistance to fire.

Acrylic

Acrylic resin is generally used where a high degree of protection is required against the effects of fire such as low smoke, fire propagation and flame spread.

Vinylester

Vinylester is generally used in applications when additional protection is required against the effects of certain corrosive chemicals.

3.4 Loadings

In order to select and design the most appropriate cable ladder or cable tray system for an installation it is important to consider the necessary loads which will need to be supported and the distance between the supports, otherwise known as the span. The type of loads imposed on cable ladder or tray installations can be classed as distributed or point loads, dead loads or imposed loads. A cautious design approach should be taken when planning a cable support system.

3.4.1 Dead loads

These loads include the weight of any cable, pipes and secondary equipment carried on or installed on the cable ladder or tray plus the actual weight of the cable ladder or tray and any component of the system such as covers or accessories.

When designing an installation it is usual to consider whether future changes in the pattern of demands for building services will impose increased loading requirements on the support system. It is good design practice to allow both the physical space and sufficient load carrying capacity for the future addition of approximately 25% more cables or other equipment.

Weight data for cables is readily available from the cable manufacturer or cable supplier and is usually quoted in terms of kilograms per metre (kg/m).

On some occasions it may be necessary to select a cable ladder or tray design in the absence of accurate information on the likely cable load. To help with a potential situation such as this, and to safe guard the installation, a recommended approach would be to choose a size of cable ladder or tray and to estimate the maximum cable weight which is capable of being contained within the cable ladder or cable tray. The following formula will assist in the estimation of the cable weight.

$$\text{Maximum Cable Laying Capacity (kgm}^{-1}\text{)} = \text{Cable Laying Cross-Sectional Area (m}^2\text{)} \times \text{The Density of the Cable (kgm}^{-3}\text{)}$$

This calculated maximum loading can then be used to select a suitable support span for the cable ladder or cable tray using the manufacturers published loading data.

The maximum cable laying capacity can be calculated by using the theoretical maximum value of 2800 for the density of the cable. In practice however, the value 2800 may be replaced by 1700 (kgm⁻³).

Weight data for secondary equipment should also be readily available from the equipment manufacturer or supplier and is usually quoted in terms of kilograms (kg). The unit weight for the secondary equipment can be converted into an equivalent weight per metre by using the following formula:

$$\text{Equivalent Weight per Metre (Kgm}^{-1}\text{)} = \frac{2 \times \text{unit of equipment (kg)}}{\text{Span (m)}}$$

For Example a secondary item of equipment with a weight of 12kg has an equivalent weight per metre W_m of 8 Kgm^{-1} for a span of 3 m. This figure should be added to the sum of the individual cable weights. When determining the location of secondary items of equipment care should be taken to either mount the item centrally across the cable ladder or tray or fix the items adjacent to or directly onto the side members and as close to a support as the installation will allow.

3.4.2 Imposed loads

Imposed loads can include wind, ice and snow. The effects of imposed loads will vary from one installation to another and further advice relating to the specific influences of each should be sought at the design stage of the installation. Appropriate design data for U.K. weather conditions is given in British Standard BS EN 1991 : 2005. The following information on imposed loads is given as a general guide.

3.4.2.1 Snow

The magnitude of the additional load imposed by snow will be influenced by a number of factors including density of the snow, the degree of drifting which will alter the profile of the snow accumulating on the cable ladder or tray and the nature of the installation (i.e. covers fitted or percentage of cable loading area occupied by cables). The density of snow can also vary depending on the level of wetness and compactness. Further details can be found from BS EN 1991-1-3:2003 Eurocode 1. Actions on structures. General actions. Snow loads.

3.4.2.2 Ice

An allowance should be made for those locations where ice formation is likely so that the total load supported by the cable ladder or tray installation can be determined.

The most common form of ice build-up is glaze ice as a result of rain or drizzle freezing on impact with an exposed object. Generally only the top surface and /or the windward side of a cable ladder or tray system is significantly coated in ice. Where cable ladder or tray is installed in areas of low temperatures where ice is likely to form, the load imposed by the ice should be calculated and added to the maximum design load.

$$L = \frac{W.T.D.}{10^6}$$

Where:-

L = Ice Load (kgm⁻¹)

W = Cable ladder/tray width (mm)

T = Maximum ice thickness (mm)

D = Ice density (kgm⁻³)

The maximum ice density will vary from location to location. The following example is calculated using a 600 mm wide ladder/tray with a load imposed by a layer of ice 10mm thick and having a density of 916kg/m³. This can be used as a conservative estimation:

$$\frac{600.10.916}{10^6} = 5.496 \text{ kgm}^{-1}$$

3.4.2.3 Wind

Wind loads exert sideways and vertical forces on cable ladder or cable tray installations. The force is a function of the wind speed and may be determined from BS EN 1991-1-4:2005 + Amendment 1:2010 (Eurocode 1. Actions on structures. General actions. Wind actions.)

Wind speed will vary relative to the height above the ground and the degree of exposure.

When covers are installed on outdoor cable ladder or cable tray, another factor to be considered is the aerodynamic effect which can produce a lift strong enough to separate a cover from an installation. Wind moving across a covered system creates a positive pressure inside the cable ladder or cable tray and a negative pressure above the cover (Bernoulli effect). This pressure difference can result in the cover being lifted off which can result in damage to the installation and possible injury to personnel or to the public.

It is recommended that closed cover types or covers with heavy duty cover clamps are used when an installation requiring covers is likely to be susceptible to strong winds.

3.5 Temperature

3.5.1 Effect of Thermal Expansion on Cable Tray and Cable Ladder

It is important that thermal expansion and contraction are considered when designing and installing a cable ladder or tray installation. Even in relatively moderate climates there will be sufficient seasonal thermal movement which could easily place undue stresses on the installation and the supporting structure.

To incorporate thermal displacement in the design of a cable ladder or cable tray installation expansion couplers should be used. For this reason it is important to establish the maximum temperature differential which is likely to be encountered at the

site of the installation. The temperature differential is based on the maximum and minimum seasonal temperatures. This temperature differential will determine the maximum spacing between expansion couplers within a cable ladder or cable tray installation.

See section 2.5.3 which gives details on expansion coupler installation.

Consult the manufacturer for more detailed information.

3.5.2 Effect of Thermal Expansion on Cables

The effect of cable expansion and contraction should also be considered and it is therefore advisable to ensure that some excess cable length, such as a loop or partial bend, is left at the position of the expansion joints.

A cable can be assumed to be an elastic body, and therefore under conditions of temperature change can expand or contract. In reality the expansion or contraction is dependent upon the material, shape and construction of the conductor and with small temperature changes it is linear until, with bigger temperature changes, it reaches a limiting value. Stresses of up to 50 N/mm² can be expected and under the influence of such stress deformation takes place.

Whether the temperature rise of a conductor produces a longitudinal expansion force or a radial expansion force largely depends on the type of conductor, the adhesion of the insulation to the conductor, the type of cable and the method of cable cleating.

In multi-core cables the radial expansion of the conductors is hindered and therefore high longitudinal forces are developed in the conductors. In single core cables longitudinal expansion occurs when the deflection of the cable is hampered due to the design of the cable fixings.

Cables must be installed and secured in such a way that longitudinal expansion is equally divided over the full length of the cable and does not occur only at a few points. This is of particular importance when installing cables of large cross sectional area which in normal operation are heavily loaded with large cyclical currents.

Single core cables must be installed in long straight runs in a wavy line. Cables must be fixed to supports at sufficiently large distances to permit deflection. During the installation of cables the minimum bending radii must be strictly observed so as to avoid the development of excessive radial stresses in the bends and hence the possibility of damage to the insulation and outer sheath. Single core cables must be installed in such a way that damage e.g. pressure points caused by thermal expansion, are avoided. This can be achieved by installing the cables in an approximate sine-wave form and fixing at the 'peaks' of each of these waves. Sufficient space must be provided on the cable tray and cable ladder to accommodate the maximum deflection of the cable under normal operation. Further advice should be given by the cable manufacturer.

SECTION 4

Health & Safety



All installations will be subject to health & safety regulations.

In some environments where safety is critical due to the local conditions, there may be additional limitations on the type of permissible materials and installation processes which may, for example, be in place to prevent the risk of sparks in potentially explosive areas, or to prevent the risk of contamination.

Installers should always be familiar with the health & safety regulations and if any such additional limitations may apply.

SECTION 5

Maintenance

As cable trays, ladders & channel supports are generally designed with no freely moving parts, there is very little maintenance activity required. When correctly installed, these systems can provide a rigid supporting structure with a long life span.

5.1 Inspection

Cable trays, ladders & channel under normal conditions are virtually maintenance free. However, under a facility's routine maintenance schedule for electrical equipment there may be a requirement to periodically inspect the containment systems.

As equipment cannot be maintained at all times, a maintenance schedule may be required to decide when it is proper to perform checks. Under normal conditions, visual maintenance should be considered sufficient.

Visual checks should be made at all points of connection to ensure fixings & fastenings are sound. Any suspect areas should be tightened to the manufacturer's recommendations.

Visual checks should also be made for deposits of foreign objects and debris. Any items considered to be fouling the cableways should be removed.

Visual checks should be performed for evidence of corrosion particularly where dissimilar metals are in contact with one another. See section 3.1 for further details.

It is recommended that any maintenance functions are carried out by qualified personnel at the earliest opportunity.

When trays, ladders & channel supports have been subjected to seismic activity, unusual weather patterns or any other abnormalities, it is recommended that an inspection is carried out and any remedial activity undertaken.

5.2 Removal of cables

Although inactive or dead cables may be left inside a tray or ladder system, it is good practice to remove these cables to free up future cable carrying capacity & to improve ventilation in the remaining system. Removal of these cables should only be carried out by a competent person.

5.3 On site repairs

Where damage to an existing cable tray, cable ladder or support has occurred, it may be necessary to make some corrective maintenance. This damage may be represented by, for example, broken welds, bent ladder rungs or severely deformed side rails etc. It is recommended, depending on the degree of damage, that the section is replaced rather than repaired to maintain the overall integrity of the installation. Provided adequate support is in place, components may be fairly easily replaced by a competent person.

SECTION 6

Sustainability



BEAMA members fully subscribe to the principles of sustainable development as outlined below:

6.1 Sustainable development

Sustainable development can be defined as development that satisfies the needs of the present without compromising the ability of future generations to satisfy theirs. Sustainable development includes, respect for the environment, and preventing the exhaustion of natural resources by the reduction of waste and the minimisation of energy consumption.

6.2 REACH regulations

The new European REACH regulations came into force on 1st June 2007. REACH stands for 'Registration, Evaluation and Authorisation of Chemicals'. The main objectives of REACH are: better protection of human health and the environment against the risks that can be caused by chemicals. It also promotes better knowledge of the chemical substances used in industry.

REACH regulations concern all industries and all materials that exist on the European market, whether produced in the European Union or imported, from one tonne per year. It obliges companies to register their substances with the European Chemicals Agency; otherwise, they will not be authorised for placement on the European market. Nevertheless, this registration is not applicable to substances already covered by other regulations (radioactive substances, medication, phytopharmaceutical products, biocidal products, food additives, etc.). Other categories, such as polymers, are subject to special handling.

6.3 The management of WEEE and RoHS

The management of WEEE and RoHS corresponds to two European directives. D3E (2002/96/EC) deals with the framework for the management of waste electrical and electronic equipment in Europe. The RoHS recast Directive 2011/65/EU (Restriction of Hazardous Substances) concerns the composition of electrical and electronic equipment (EEE).

One of the aims of these directives is to inform users of the rules to apply and the means available to manage waste electrical and electronic equipment in strict observance of sustainable development. These directives also identify the needs and problems of users and service providers, and solutions that exist or need to be created.

The aims are to handle the economic management of the WEEE sector, to organise the collection and processing of WEEE, and to implement awareness, information, and communication actions.

WEEE includes a wide variety of waste, and their typical composition is too complex to be fully defined. The waste electrical and electronic equipment collection and processing system has been operational for professional WEEE since 13th August 2005.

This waste essentially consists of ferrous and non-ferrous metals (10 to 85%), inert materials excluding cathode ray tubes (0 to 20%), plastics whether or not containing halogenated flame-retardant materials (1 to 70%), and specific components that are potentially hazardous to health and the environment (CFCs and other greenhouse gases).

Note: cable ladder systems and cable tray systems and associated supports are outside of the scope of WEEE and RoHS.

6.4 Environmental footprint

Product Environmental Profiles (PEPs) specify the environmental characteristics of each product over its entire life cycle.

The following points must be addressed:

- Take environmental aspects into account in the design,
- Preservation of resources (energy, water, materials, land),
- Protection of ecosystems on a global level (climate, ozone), regional level (forests, rivers, etc.), and local level (waste, air quality, etc.).
- Links between environment and health.

SECTION 7

Applicable Standards



BS EN 61537	Cable management. Cable tray systems and cable ladder systems
BS 6946	Specification for metal channel cable support systems for electrical installations.
BS EN ISO 1461	Hot dip galvanized coatings on fabricated iron and steel articles. Specifications and test methods
BS 7671	Requirements for electrical installations. IEE Wiring Regulations. Seventeenth edition
BS EN 50174-1	Information technology. Cabling installation. Installation specification and quality assurance
BS EN 50174-2	Information technology. Cabling installation. Installation planning and practices inside buildings
BS 6701	Telecommunications equipment and telecommunications cabling. Specification for installation, operation and maintenance.
BS EN ISO 14713-1	Zinc coatings. Guidelines and recommendations for the protection against corrosion of iron and steel in structures. General principles of design and corrosion resistance
BS EN 10346	Continuously hot-dip coated steel flat products. Technical delivery conditions
BS EN 13811	Sherardizing. Zinc diffusion coatings on ferrous products. Specification
BS EN ISO 2081	Metallic and other inorganic coatings. Electroplated coatings of zinc with supplementary treatments on iron or steel
BS EN ISO 12683	Mechanically deposited coatings of zinc. Specification and test methods
BS EN 10143	Continuously hot-dip coated steel sheet and strip. Tolerances on dimensions and shape
BS EN 10088-1	Stainless steels. List of stainless steels
BS EN 10088-2	Stainless steels. Technical delivery conditions for sheet/plate and strip of corrosion resisting steels for general purposes
BS EN 10088-3	Stainless steels. Technical delivery conditions for bars, rods, wire, sections and bright products of corrosion resisting steels for construction purposes
BS EN 1991-1-3	Eurocode 1. Actions on structures. General actions. Snow loads
BS EN 1991-1-4	Eurocode 1. Actions on structures. General actions. Wind actions
PD 6484	'Commentary on corrosion at bimetallic contacts and its alleviation.'
BS EN 61914	Cable cleats for electrical installations

Companies involved in the preparation of this Guide

Cablofil UK Ltd

Unit 9 Ashville Way
Ashville Industrial Estate
Sutton Weaver
WA7 3EZ
United Kingdom

Tel: +44 (0) 845 1304 628
Fax: +44(0) 845 1304 629
Email: salesuk@cablofil.com
www.cablofil.co.uk

Ellis Patents Ltd

High Street
Rillington
Malton
North Yorkshire.
YO17 8LA
United Kingdom

Tel: +44(0)1944 758395
Fax: +44 (0)1944 758808
Email: sales@ellispatents.co.uk
www.ellispatents.co.uk

Legrand Electric Ltd

Great King Street North
Birmingham
B19 2LF
United Kingdom

Customer Services:

Tel: +44 (0) 845 605 4333
Fax: +44 (0) 845 605 4334
Email: legrand.sales@legrand.co.uk

Technical Support:

Tel: +44 (0) 870 608 9020
Fax: +44 (0) 870 608 9021
Email: Technical.uk@legrand.co.uk
www.legrand.co.uk
www.legrand3d.co.uk

Marco Cable Management

Unit 8,
Bryn Cefni Industrial Park,
Llangeferri,
Anglesey,
LL77 7XA
United Kingdom

Tel: +44(0)1248 725772
Fax: +44(0)1248 725788
Email: sales@marcocm.com
www.marcocm.com

Metsec Plc

Cable Management Division
Broadwell Road
Oldbury
B69 4HF
United Kingdom

Tel : +44(0)121 601 6085
Fax : +44(0)121 601 6177
Email :
cablemanagement@metsec.com
www.metsec.com

Schneider Electric Ltd

Stafford Park 5
Telford
Shropshire
TF3 3BL
United Kingdom

Tel: +44 (0) 1952 290029
Fax: +44 (0) 1952 292238
www.schneider.co.uk

Unistrut Ltd

Delta Point
Greets Green Road
West Bromwich
B70 9PL
United Kingdom

Tel: +44(0)1215 806300
Email: uksales@unistrut.com
www.unistrut.com

Unitrunk Ltd

Blaris Industrial Estate,
4 Altona Road,
Lisburn,
Co. Antrim,
BT27 5QB
N. Ireland

Tel: +44 (0)2892 625100
Fax: +44 (0)2892 625101
Email: lisburn@unitrunk.co.uk
www.unitrunk.co.uk

Vantrunk Ltd.

Goddard Road, Astmoor
Runcorn,
Cheshire
WA7 1QF
United Kingdom

Tel: +44(0)1928 564211
Fax: +44(0)1928 580157
Email: sales@vantrunk.co.uk
www.vantrunk.co.uk



BEAMA Limited

Westminster Tower

3 Albert Embankment

London

SE1 7SL

Telephone: +44 (0)20 7793 3000

Fax: +44 (0)20 7793 3003

Email: info@beama.org.uk

www.beama.org.uk

BEAMA Limited is registered in England No. 84313